

# TASCAM

D01152220A

# X-48MKII

## 48 Track Digital Audio Workstation

### OWNER'S MANUAL

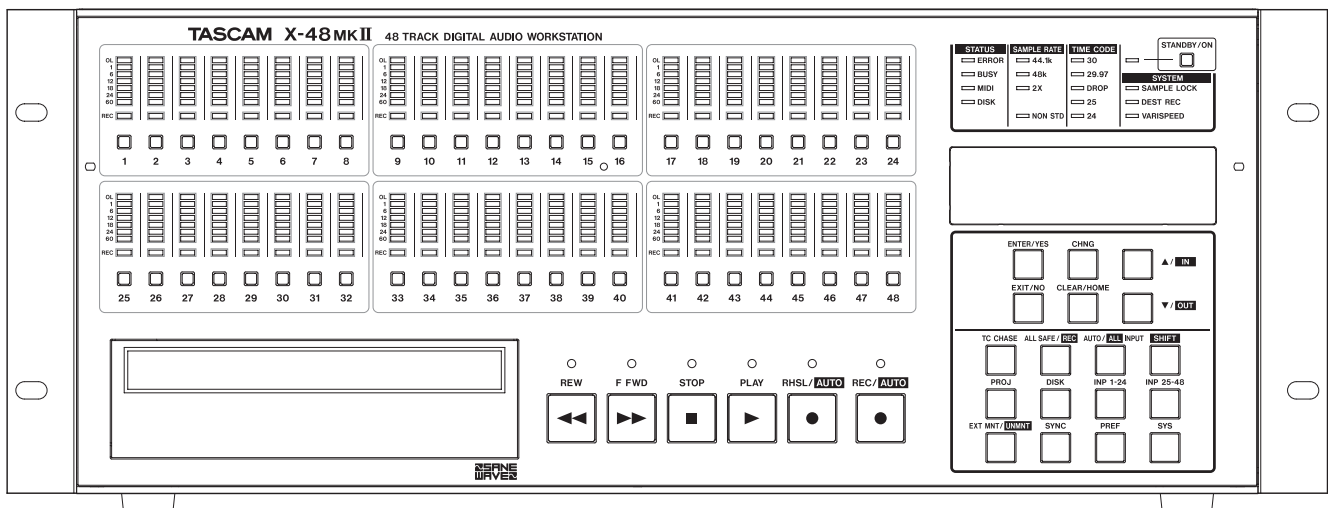

# IMPORTANT SAFETY PRECAUTIONS



**CAUTION**  
RISK OF ELECTRIC SHOCK  
DO NOT OPEN



**CAUTION:** TO REDUCE THE RISK OF ELECTRIC SHOCK, DO NOT REMOVE COVER (OR BACK). NO USER-SERVICEABLE PARTS INSIDE. REFER SERVICING TO QUALIFIED SERVICE PERSONNEL.



The lightning flash with arrowhead symbol, within equilateral triangle, is intended to alert the user to the presence of uninsulated "dangerous voltage" within the product's enclosure that may be of sufficient magnitude to constitute a risk of electric shock to persons.



The exclamation point within an equilateral triangle is intended to alert the user to the presence of important operating and maintenance (servicing) instructions in the literature accompanying the appliance.

**WARNING: TO PREVENT FIRE OR SHOCK HAZARD, DO NOT EXPOSE THIS APPLIANCE TO RAIN OR MOISTURE.**

For U.S.A.

TO THE USER

This equipment has been tested and found to comply with the limits for a Class A digital device, pursuant to Part 15 of the FCC Rules. These limits are designed to provide reasonable protection against harmful interference when the equipment is operated in a commercial environment. This equipment generates, uses, and can radiate radio frequency energy and, if not installed and used in accordance with the instruction manual, may cause harmful interference to radio communications.

Operation of this equipment in a residential area is likely to cause harmful interference in which case the user will be required to correct the interference at his own expense.

### CAUTION

Changes or modifications to this equipment not expressly approved by TEAC CORPORATION for compliance could void the user's authority to operate this equipment.

## ■ For European Customers

### WARNING

This is a Class A product. In a domestic environment, this product may cause radio interference in which case the user may be required to take adequate measures.

### CE Marking Information

- a) Applicable electromagnetic environment: E4
- b) Peak inrush current: 20 A

### Disposal of electrical and electronic equipment

- (a) All electrical and electronic equipment should be disposed of separately from the municipal waste stream via collection facilities designated by the government or local authorities.
- (b) By disposing of electrical and electronic equipment correctly, you will help save valuable resources and prevent any potential negative effects on human health and the environment.
- (c) Improper disposal of waste electrical and electronic equipment can have serious effects on the environment and human health because of the presence of hazardous substances in the equipment.
- (d) The Waste Electrical and Electronic Equipment (WEEE) symbol, which shows a wheeled bin that has been crossed out, indicates that electrical and electronic equipment must be collected and disposed of separately from household waste.



- (e) Return and collection systems are available to end users. For more detailed information about the disposal of old electrical and electronic equipment, please contact your city office, waste disposal service or the shop where you purchased the equipment.

This appliance has a serial number located on the rear panel. Please record the model number and serial number and retain them for your records.

Model number \_\_\_\_\_

Serial number \_\_\_\_\_

# IMPORTANT SAFETY INSTRUCTIONS

- 1 Read these instructions.
  - 2 Keep these instructions.
  - 3 Heed all warnings.
  - 4 Follow all instructions.
  - 5 Do not use this apparatus near water.
  - 6 Clean only with dry cloth.
  - 7 Do not block any ventilation openings. Install in accordance with the manufacturer's instructions.
  - 8 Do not install near any heat sources such as radiators, heat registers, stoves, or other apparatus (including amplifiers) that produce heat.
  - 9 Do not defeat the safety purpose of the polarized or grounding-type plug. A polarized plug has two blades with one wider than the other. A grounding type plug has two blades and a third grounding prong. The wide blade or the third prong are provided for your safety. If the provided plug does not fit into your outlet, consult an electrician for replacement of the obsolete outlet.
  - 10 Protect the power cord from being walked on or pinched particularly at plugs, convenience receptacles, and the point where they exit from the apparatus.
  - 11 Only use attachments/accessories specified by the manufacturer.
  - 12 Use only with the cart, stand, tripod, bracket, or table specified by the manufacturer, or sold with the apparatus. When a cart is used, use caution when moving the cart/apparatus combination to avoid injury from tip-over.
- Do not expose this apparatus to drips or splashes.
  - Do not place any objects filled with liquids, such as vases, on the apparatus.
  - Do not install this apparatus in a confined space such as a book case or similar unit.
  - The apparatus draws nominal non-operating power from the AC outlet with its POWER or STANDBY/ON switch not in the ON position.
  - The apparatus should be located close enough to the AC outlet so that you can easily grasp the power cord plug at any time.
  - The mains plug is used as the disconnect device, the disconnect device shall remain readily operable.
  - Products with Class I construction are equipped with a power supply cord that has a grounding plug. The cord of such a product must be plugged into an AC outlet that has a protective grounding connection.
  - If the product uses batteries (including a battery pack or installed batteries), they should not be exposed to sunshine, fire or excessive heat.
  - CAUTION for products that use replaceable lithium batteries: there is danger of explosion if a battery is replaced with an incorrect type of battery. Replace only with the same or equivalent type.
  - Caution should be taken when using earphones or headphones with the product because excessive sound pressure (volume) from earphones or headphones can cause hearing loss.



- 13 Unplug this apparatus during lightning storms or when unused for long periods of time.
- 14 Refer all servicing to qualified service personnel. Servicing is required when the apparatus has been damaged in any way, such as power-supply cord or plug is damaged, liquid has been spilled or objects have fallen into the apparatus, the apparatus has been exposed to rain or moisture, does not operate normally, or has been dropped.

# Safety Information

This product has been designed and manufactured according to FDA regulations "title 21, CFR, chapter 1, subchapter J, based on the Radiation Control for Health and Safety Act of 1968", and is classified as a class 1 laser product. There is no hazardous invisible laser radiation during operation because invisible laser radiation emitted inside of this product is completely confined in the protective housings.

The label required in this regulation is shown at ①.

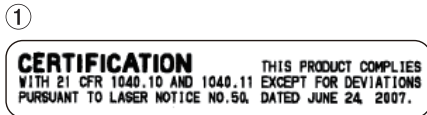

For U.S.A.

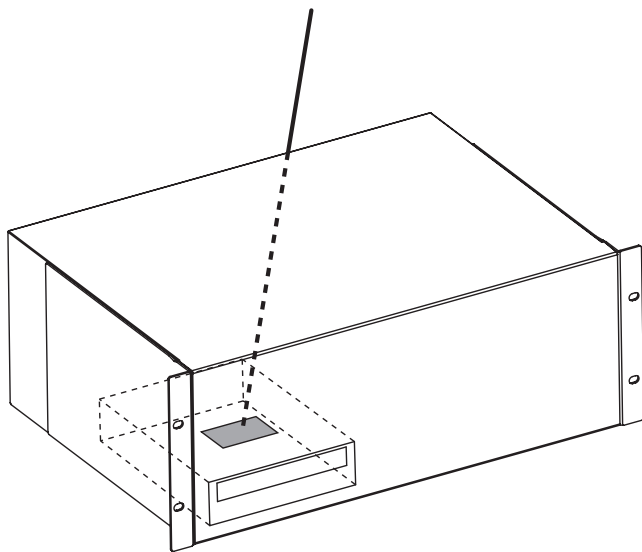

## Optical pickup

Type: OWY 8/35, OWY 8/36, OWY8/44, OWY8/45  
 Manufacturer: Pioneer CORP.  
 Laser output (CD): Less than 1.3mW (Play) and 104.7mW (Record) on the objective lens  
 (DVD): Less than 1.08mW (Play) and 102mW (Record) on the objective lens  
 Wavelength: 777-787 nm (CD)  
 656-663 nm (DVD)

For China

产品有毒有害物质或元素的名称及含量

| 机种: X-48MK II |              | 有毒有害物质或元素 |        |        |               |            |              |
|---------------|--------------|-----------|--------|--------|---------------|------------|--------------|
|               | 品名           | 铅 (Pb)    | 汞 (Hg) | 镉 (Cd) | 六价铬 (Cr (VI)) | 多溴联苯 (PBB) | 多溴二苯醚 (PBDE) |
| 1             | CHASSIS部份    | ○         | ○      | ○      | ○             | ○          | ○            |
| 2             | DRIVE UNIT部份 | ×         | ○      | ○      | ○             | ○          | ○            |
| 3             | 线材部份         | ○         | ○      | ○      | ○             | ○          | ○            |
| 4             | PCB Assy部份   | ×         | ○      | ○      | ○             | ○          | ○            |
| 5             | 电源部份         | ×         | ○      | ○      | ○             | ○          | ○            |
| 6             | 附属品部份        | ○         | ○      | ○      | ○             | ○          | ○            |
| 7             | SEAL部份       | ○         | ○      | ○      | ○             | ○          | ○            |
| 8             | 包装部份         | ○         | ○      | ○      | ○             | ○          | ○            |

○: 表示该有毒有害物质在该部件所有均质材料中的含量均在 SJ/T11363-2006 标准规定的限量要求以下。

×: 表示该有毒有害物质至少在该部件的某一均质材料中的含量超出 SJ/T11363-2006 标准规定的限量要求。

(针对现在代替技术困难的电子部品及合金中的铅)

## CAUTION

- DO NOT REMOVE THE PROTECTIVE HOUSING USING A SCREWDRIVER.
- USE OF CONTROLS OR ADJUSTMENTS OR PERFORMANCE OF PROCEDURES OTHER THAN THOSE SPECIFIED HEREIN MAY RESULT IN HAZARDOUS RADIATION EXPOSURE.
- IF THIS PRODUCT DEVELOPS TROUBLE, CONTACT YOUR NEAREST QUALIFIED SERVICE PERSONNEL, AND DO NOT USE THE PRODUCT IN ITS DAMAGED STATE.
- CLASS 1M INVISIBLE LASER RADIATION WHEN OPEN AND INTERLOCKS DEFEATED. DO NOT VIEW DIRECTLY WITH OPTICAL INSTRUMENTS.

## ■ Rack-mounting the Unit

Use the supplied rack-mounting kit to mount the unit in a standard 19-inch rack, as shown below.

Remove the feet of the unit before mounting.

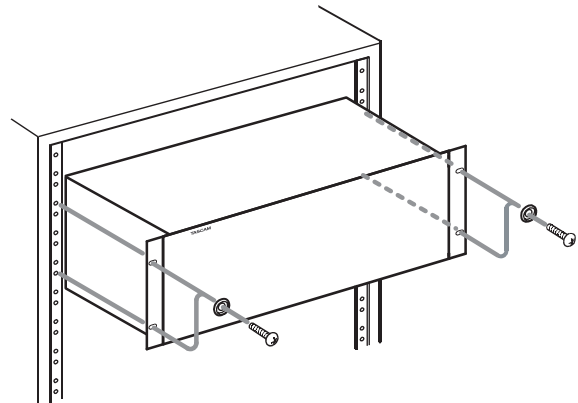

- Leave 2U of space above the unit for ventilation.
- Allow at least 10 cm (4 in) at the rear of the unit for ventilation.

|   |           |                                      |           |
|---|-----------|--------------------------------------|-----------|
| <b>1 – Introduction .....</b>                 | <b>7</b>  | I/O Settings.....                    | 20        |
| Features .....                                | 7         | Analog I/O Operating Level.....      | 20        |
| Unpacking .....                               | 7         | Control Mode .....                   | 20        |
| Manual Conventions.....                       | 8         | MIDI Device ID.....                  | 21        |
| Required Equipment.....                       | 8         | Sony 9-Pin.....                      | 21        |
| Intellectual property rights .....            | 8         | Video Reference .....                | 21        |
| Precautions for placement and use.....        | 9         | Pull Up/Pull Down Sample Rates.....  | 21        |
| Connecting the power .....                    | 9         | Networking .....                     | 22        |
| Beware of condensation.....                   | 9         | Checking Free Hard Drive Space ..... | 23        |
| Other precautions.....                        | 9         | Drive Benchmarking Utility .....     | 23        |
| Cleaning the unit.....                        | 9         | Formatting a New Drive .....         | 24        |
| About optical discs.....                      | 9         | Factory Defaults .....               | 24        |
| Handling of optical discs .....               | 9         | Store/Recall User Settings.....      | 24        |
| Supported optical media .....                 | 10        | Mixer Bypass .....                   | 25        |
| <b>2 – Names and Functions of Parts .....</b> | <b>11</b> | Make a Default Project.....          | 25        |
| Front panel.....                              | 11        | <b>5 – Recorder .....</b>            | <b>26</b> |
| Rear panel.....                               | 12        | Working With Projects .....          | 26        |
| <b>3 – Setup.....</b>                         | <b>14</b> | Creating a New Project .....         | 26        |
| I/O Card Installation .....                   | 14        | Destructive versus Non-Destructive   |           |
| Making Connections.....                       | 14        | Recording.....                       | 26        |
| TDIF .....                                    | 14        | Opening a Project.....               | 26        |
| S/PDIF .....                                  | 14        | Saving a Project .....               | 27        |
| AES/EBU.....                                  | 14        | Auto-Saving Projects .....           | 27        |
| ADAT .....                                    | 14        | Importing a Project .....            | 27        |
| Digital Audio Clock.....                      | 14        | Exporting a Project.....             | 27        |
| Word Clock .....                              | 14        | Copying a Project.....               | 28        |
| Analog Audio.....                             | 15        | Backing Up a Project to CD/DVD ..... | 28        |
| Synchronization and Control.....              | 15        | Deleting a Project .....             | 28        |
| MIDI.....                                     | 15        | Load Last Project.....               | 29        |
| Time Code.....                                | 15        | Transport Operations .....           | 29        |
| Footswitch .....                              | 15        | Local.....                           | 29        |
| Remote (Sony 9-Pin).....                      | 15        | One-Button Record .....              | 29        |
| Video Reference (Tri Level Sync).....         | 15        | TC Chase .....                       | 29        |
| Keyboard, Mouse & Monitor .....               | 16        | Rehearse .....                       | 30        |
| Network.....                                  | 16        | Pre/Post Roll.....                   | 30        |
| External Drives .....                         | 16        | Varispeed .....                      | 30        |
| Powering On / Standby.....                    | 16        | Recording as a timecode slave .....  | 30        |
| External Applications .....                   | 16        | Recording and Playing Back.....      | 30        |
| MX-View.....                                  | 16        | Input Monitoring.....                | 30        |
| TASCAM Mixer Companion .....                  | 16        | Record Enable .....                  | 31        |
| Using the X-48MKII System Restore CD .....    | 17        | Punch Crossfade Time.....            | 31        |
| <b>4 – Configuration .....</b>                | <b>18</b> | Undo/Redo .....                      | 31        |
| Display Settings.....                         | 18        | Metering.....                        | 31        |
| Setting the date and time .....               | 18        | Using Markers.....                   | 32        |
| Navigating the LCD Interface.....             | 18        | Loop Playback .....                  | 32        |
| Sample Rates .....                            | 18        | Loop Mode .....                      | 33        |
| Digital Audio Clock.....                      | 19        | Auto Punch.....                      | 33        |
|   |           | Loop Recording .....                 | 34        |

# Contents

|  |           |  |           |
|--|-----------|--|-----------|
| Audio pool .....                               | 34        | History List .....                                 | 44        |
| Using the VGA Recorder Interface .....         | 34        | Moving clip borders and adjusting crossfades ..... | 44        |
| Meters.....                                    | 34        | Fade-in, fade-out and crossfade curves.....        | 45        |
| Naming Tracks.....                             | 34        | Audio Processing.....                              | 45        |
| Scrolling.....                                 | 34        | Pitch/Time Stretch .....                           | 45        |
| Timebar Format .....                           | 35        | Consolidate .....                                  | 45        |
| Clip Properties.....                           | 35        | <b>7 – Mixer .....</b>                             | <b>46</b> |
| Navigating the Timeline .....                  | 35        | Mixer Interface .....                              | 46        |
| Status Displays .....                          | 35        | Mixer Introduction.....                            | 46        |
| Changing part colors on the track screen ..... | 35        | Mixer Bypass .....                                 | 46        |
| Synchronization.....                           | 35        | DSP View .....                                     | 46        |
| Requirements.....                              | 35        | Mixer Tabs.....                                    | 46        |
| Sample Rate .....                              | 36        | Automation .....                                   | 47        |
| Clock Source.....                              | 36        | Third-Party Plug Ins.....                          | 47        |
| BNC Clock In/BNC Clock Out.....                | 37        | Routing .....                                      | 47        |
| BNC Word Clock Output Polarity.....            | 37        | Mixer Applications.....                            | 47        |
| Video Clock Frame-Edge Resolve.....            | 37        | Submixing.....                                     | 47        |
| Frame Rate.....                                | 37        | Monitoring While Recording.....                    | 47        |
| Control Mode.....                              | 38        | Final Mix.....                                     | 48        |
| Chase Freewheel .....                          | 39        | <b>8 – Specifications .....</b>                    | <b>49</b> |
| Chase Relock.....                              | 39        | Media and formats .....                            | 49        |
| Chase Relock Threshold.....                    | 39        | Digital audio input/output .....                   | 49        |
| Timecode Offset.....                           | 40        | Control input/output.....                          | 49        |
| Chase Lock Deviation .....                     | 40        | General .....                                      | 49        |
| Timecode Output Muting.....                    | 40        | Options .....                                      | 50        |
| Advanced Recorder Operations .....             | 40        | Dimensional drawings .....                         | 50        |
| Audio File Naming .....                        | 40        | <b>9 – Appendix .....</b>                          | <b>51</b> |
| Track Key Punch .....                          | 41        | Functions controlled using a mouse and display..   | 51        |
| Recording time .....                           | 41        | Front panel function list .....                    | 54        |
| <b>6 – Editing.....</b>                        | <b>42</b> | Shortcuts.....                                     | 57        |
| Edit Tools.....                                | 42        | MIDI machine control (MMC) protocol .....          | 59        |
| I-Beam Tool.....                               | 42        | SONY P2 protocol.....                              | 59        |
| Object Tool.....                               | 42        |  |           |
| Smart Tool.....                                | 42        |  |           |
| Magnify Tool .....                             | 42        |  |           |
| Selecting & Editing .....                      | 43        |  |           |
| Selecting Clips.....                           | 43        |  |           |
| Selecting Time .....                           | 43        |  |           |
| In and Out Points.....                         | 43        |  |           |
| Clip Properties.....                           | 43        |  |           |
| Snap to Grid .....                             | 43        |  |           |
| Cut, Copy, Delete, Paste .....                 | 43        |  |           |
| Repeat Paste .....                             | 43        |  |           |
| Crop.....                                      | 43        |  |           |
| Insert Time.....                               | 44        |  |           |
| Delete Time .....                              | 44        |  |           |
| Split .....                                    | 44        |  |           |
| Play From Selection.....                       | 44        |  |           |

Thank you very much for purchasing the TASCAM X-48MKII 48 Track Digital Audio Workstation.

Before connecting and using the unit, please take time to read this manual thoroughly to ensure you understand how to properly set up and connect the unit, as well as the operation of its many useful and convenient functions. After you have finished reading this manual, please keep it in a safe place for future reference.

You can also download the Owner's Manual from the TASCAM web site (<http://tascam.com/>).

---

## Features

---

- 48-track hard disk recorder
- Transport keys and meters on the front panel can be used to control the multitrack recorder
- 1TB hard disk built-in
- Recording to external hard disks using high-speed eSATA connection
- Built-in hard disk format: NTFS
- Audio file format: Broadcast Wave Format (BWF)
- Operation modes include standalone (unsynchronized), timecode synchronization and Theater Play
- Edit tracks using the graphical user interface (GUI), including cut, copy, delete and undo/redo
- Undo operations using the UNDO command (up to 1000 changes) and History List
- Non-real-time time compression editing
- Support for 44.1, 48, 88.2 and 96 kHz sampling frequencies, including pull-up and pull-down
- $\pm 6\%$  pitch control playback
- Support for LTC and MTC timecode synchronization
- Support for video resolve synchronization to video frame-edge for timecode synchronization
- Fail Safe Recording refreshes file headers every 5 seconds
- Digital mixer has 48 channels, 12 stereo subgroups, 6 aux sends and 1 stereo master
- Digital mixer can be used for mixing down during playback
- Each channel and group includes dynamics (compressor), 4-band EQ and 6 AUX sends
- Volume automation on all 48 channels by writing volume curves
- Internal 32-bit floating-point processing
- GUI can be controlled by connecting a display, keyboard and mouse
- 6 TDIF digital input and output connectors support a total of 48 inputs and outputs at 96 kHz sampling frequency
- 2 option card slots for 24 channels of audio input and output (analog, AES/EBU, ADAT)
- 1 coaxial stereo digital input and output (S/PDIF)
- Clock source options: internal, WORD, S/PDIF, TDIF, SLOT 1, SLOT 2
- Support for WORD SYNC IN/OUT/THRU, with WORD SYNC OUT supporting clocks at both high and normal (base) sampling frequencies
- VIDEO IN/THRU (video resolve, NTSC/PAL Black Burst and up to 1080p Tri-level HDTV Sync)
- TRS balanced LTC input and output
- MIDI IN and MIDI OUT
- Machine control using RS-422 9-pin connection
- Audio data and EDL data import (OPEN TL) and export (OPEN TL/AAF) supported
- Built-in DVD drive for backup
- Projects can be copied to external hard drives connected to the eSATA connector and USB 2.0 jacks
- Data can be transmitted to a host computer via Ethernet (supports 1000BASE-TX)
- Footswitch can trigger playback in Theater Play mode, and can be set to PLAY/STOP, PUNCH IN/OUT when in Internal mode
- 4U rackmount size
- Theater mode playlist can be used to change playback order
- Continuous recording for 48 hours
- Recording past 00:00 (24 hours)
- USB 2.0 jacks can be used to connect USB devices, including mice, keyboards, hard disks and flash memory
- Big Meter screen shows level meters for 48 tracks

---

## Unpacking

---

The X-48MKII has been packed to ensure its safety during shipment. Inspect the unit for damage immediately upon unpacking and contact the shipper or retailer if damage is discovered or items appear to be missing. Please keep all boxes and packing material in case your X-48MKII needs to be shipped in the future. Inside the shipping carton, you will find the following:

- X-48MKII Unit
- Power Cord specific to the country where you purchased it
- A rack-mounting screw kit
- Two white plastic spacers and screws for installation of digital cards (IF-AE24/IF-AD24)
- System Restore CD
- Documentation CD
- A warranty card
- This Owner's Manual

# 1 – Introduction

## Manual Conventions

The following typefaces will be used in this Owner's Manual as indicated.

- The names of keys and controls are given in the following typeface: **ENTER**.
- Messages shown on the VGA monitor are given in the following typeface: *Settings*.
- Messages shown in the alphanumeric portion of the LCD are given in the following typeface:  
Midi De ice ID.

The following icons will be used in this Owner's Manual as indicated:

### CAUTION

Instructions that should be followed to avoid injury, damage to the unit or other equipment, and loss of data.

### TIP

This icon indicates a hint or tip on using the X-48MKII.

### NOTE

This icon indicates explanation of actions in special situation and supplement.



This icon indicates instructions related to using the keyboard, mouse and monitor interface.



This icon indicates instructions related to using the front panel of the X-48MKII.

## Required Equipment

While the X-48MKII is a comprehensive piece of professional audio gear, there are other things you may need to take full advantage of its capabilities:

- A console with a minimum of 8 outputs (at least 24 is recommended) and enough inputs to handle your expected track count.
- An optional IF-AN24X analog I/O card if connecting the X-48MKII to an analog console. The IF-AN24X provides the X-48MKII with 24 analog inputs and 24 analog outputs.
- An optional digital I/O card (IF-AD24(X) or IF-AE24(X)) if connecting your X-48MKII to a digital console so equipped. These cards provide the X-48MKII with 24 digital inputs and 24 digital outputs per card.
- Analog or digital cables appropriate to your console and choice of I/O format.
- In order to use the X-48MKII's editing, DSP and mixing capabilities, you will need a VGA monitor (1024 x 768

minimum resolution), a two-button PC mouse (PS/2 or USB) and a PC keyboard (PS/2 or USB).

## Intellectual property rights

- TASCAM is a trademark of TEAC Corporation, registered in the U.S. and other countries.
- Microsoft, Windows, Windows Embedded and Windows Vista are either registered trademarks or trademarks of Microsoft Corporation in the United States and/or other countries.
- Apple, Macintosh, Mac OS and Mac OS X are trademarks of Apple Inc., registered in the U.S. and other countries.
- The SANEWAVE logo is a trademark of Tudor Products Inc.
- Other company names, product names and logos in this document are the trademarks or registered trademarks of their respective owners.

Any data, including, but not limited to information, described herein are intended only as illustrations of such data and/or information and not as the specifications for such data and/or information. TEAC Corporation disclaims any warranty that any use of such data and/or information shall be free from infringement of any third party's intellectual property rights or other proprietary rights, and further, assumes no liability of whatsoever nature in the event of any such infringement, or arising from or connected with or related to the use of such data and/or information.

This product is designed to help you record and reproduce sound works to which you own the copyright, or where you have obtained permission from the copyright holder or the rightful licensor. Unless you own the copyright, or have obtained the appropriate permission from the copyright holder or the rightful licensor, your unauthorized recording, reproduction or distribution thereof may result in severe criminal penalties under copyright laws and international copyright treaties. If you are uncertain about your rights, contact your legal advisor. Under no circumstances will TEAC Corporation be responsible for the consequences of any illegal copying performed using the recorder.



---

## Precautions for placement and use

---

- The operating temperature should be between 5°C and 35°C (41°F and 95°F).
- Do not install in the following types of places. Doing so could degrade the sound quality and/or cause malfunctions.
  - Places with significant vibrations or that are otherwise unstable
  - Near windows or other places exposed to direct sunlight
  - Near heaters or other extremely hot places
  - Extremely cold places
  - Places with bad ventilation or high humidity
  - Very dusty locations
- Make sure that the unit is mounted in a level position for correct operation.
- Do not place any object on the unit for heat dissipation.
- Avoid installing this unit on top of any heat-generating electrical device such as a power amplifier.

---

## Connecting the power

---

- Insert the included power cord into the **AC IN** connector completely.
- Hold the power cord by the plug when connecting or disconnecting it.

---

## Beware of condensation

---

If the unit is moved from a cold to a warm place, or used immediately after a cold room has been heated or otherwise exposed to a sudden temperature change, condensation could occur. Should this happen, leave the unit for one or two hours before turning the unit on.

---

## Other precautions

---

- Do not change the BIOS settings of this unit. Changing them could cause the unit to not start up or otherwise malfunction. Please be aware that repairing problems caused by changing BIOS settings will require payment.
- When using the included System Restore CD to reinstall the system, always disconnect all external hard disks connected by eSATA or USB, including USB flash drives. Failure to do so will result in erasing all data on these external hard disks.
- Before connecting or disconnecting anything to a connector, turn OFF the power of this unit and the devices being connected (particularly, with VGA and

similar connections). Failure to do so could cause this unit or connected equipment to be damaged.

---

## Cleaning the unit

---

To clean the unit, wipe it gently with a soft dry cloth. Do not wipe with chemical cleaning cloths, benzene, paint thinner, ethyl alcohol or other chemical agents to clean the unit as they could damage the surface.

The inside of the unit should be cleaned about once every five years. If the unit is not cleaned for a long time and dust is allowed to accumulate inside it, this could cause fire or malfunction. In particular, it is more effective to clean the inside of the unit before seasons with high humidity. Please contact a retailer that sells the unit or a TASCAM service center for cleaning and information about the cleaning fee.

---

## About optical discs

---

---

### Handling of optical discs

---

- Always place the discs in the tray with their label facing upward. (Only single-sided discs can be used with this unit.)
- To remove a disc from its case, press down on the center of the disc holder, then lift the disc out, holding it carefully by the edges.
- Do not touch the data side (the unlabeled side). Fingerprints, oils and other substances can cause errors.
- To clean the data side of a disc, wipe gently with a soft dry cloth from the center towards the outside edge. Dirt on discs can cause errors, so clean them and always store them in a clean state.
- Do not use any record spray, anti-static solutions, benzene, paint thinner or other chemical agents to clean discs as they could damage the delicate surface. It may cause discs to become unusable.
- Always store discs in their cases to avoid dirt and dust accumulating on their surfaces.
- Do not place the unit where it is exposed to direct sunlight, high temperatures or high humidity. Remaining in such a place for a long time could result in warping and other damage.
- Do not try to use 8 cm (single) discs, "business card" discs and other nonstandard discs for recording. This unit cannot record to such discs. Use standard 12 cm discs for recording.
- When labeling discs, always use a soft oil-based felt-tipped pen to write the information. Never use a ball-point or hard-tipped pen, as this may cause damage to the recorded side.

# 1 – Introduction

- Do not apply labels or other materials to discs. Do not use discs that have had tape, stickers or other materials applied to their surface. Do not use discs that have sticky residue from stickers, etc. Such discs could become stuck in the unit or cause it to malfunction.
- Do not use commercially available lens cleaners because the high-speed rotation of such discs could break the lens protection mechanism.
- Never use a commercially available disc stabilizer. Using stabilizers with this unit will damage the mechanism and cause it to malfunction.
- Do not use cracked discs.
- Only use circular compact discs. Avoid using non-circular promotional, etc. discs.

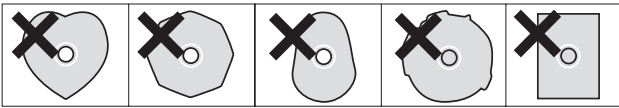

- If you are in any doubt as to the care and handling of a disc, read the precautions supplied with the disc, or contact the disc manufacturer directly.

---

## Supported optical media

This unit supports the following types of media use.

|        |                           |
|--------|---------------------------|
| DVD-R  | Reading/writing           |
| DVD-RW | Reading/writing/rewriting |
| DVD+R  | Reading/writing           |
| DVD+RW | Reading/writing           |
| CD-R   | Reading/writing           |
| CD-RW  | Reading/writing/rewriting |

This unit does not support the following types of media use.

DVD+RW          Rewriting

Dual layer media

CD-R and CD-RW discs sold for music

CD-RW disks that have been used as CD-DA

## 2 – Names and Functions of Parts

### Front panel

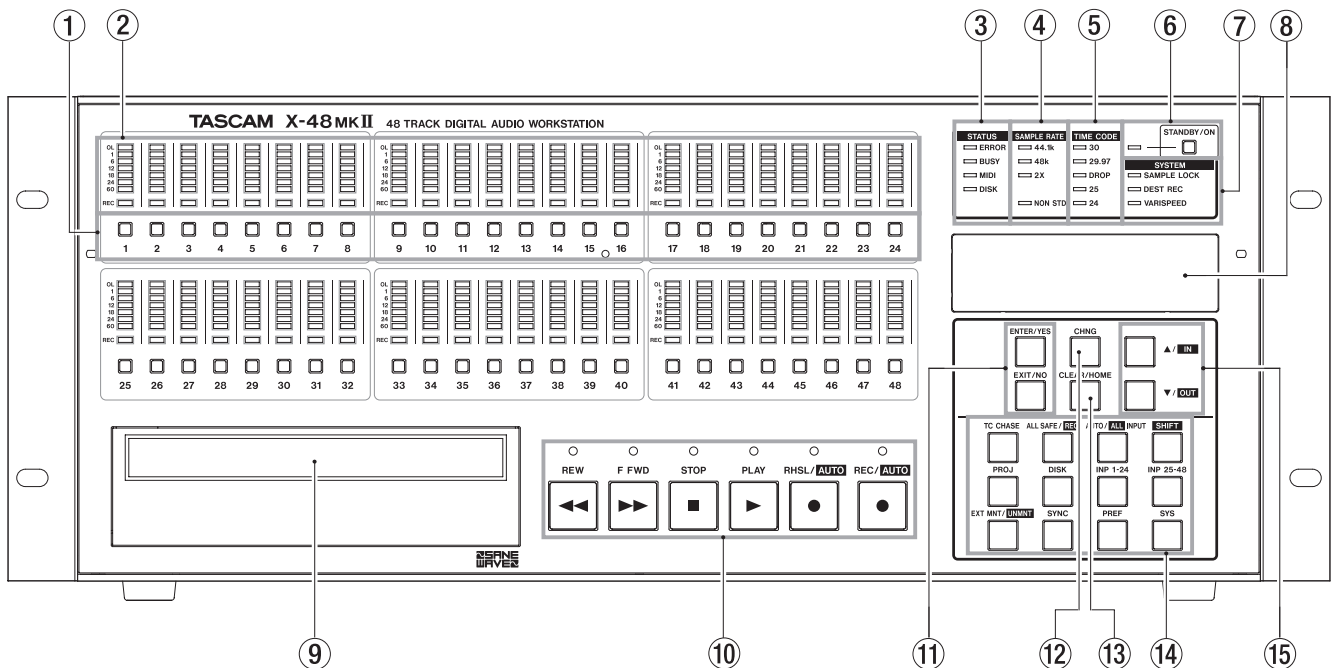

- ① **Track record arming button**  
Puts that track into record ready unless “All Safe” is turned on. Record Ready status is reported by a flashing red light directly above that track’s record arming button.
- ② **Track meter**  
Displays signal level from  $-60$  dBfs to  $-1$  dBfs and overload.
- ③ **Status Lights**  
These lights flash when the X-48MKII is accessing the hard drive, busy with a task, has MIDI input or encounters an error.

#### CAUTION

When the **BUSY** indicator is lit, do not try to save or conduct other important operations.

- ④ **Sample Rate**  
These lights report the current sample rate. If the X-48MKII is set to 96 kHz, the **48k** and **2X** lights will be lit. If it isn’t set to one of these standard rates (i.e. 47952 Hz/48k pulldown), the **NON STD** light will turn on.
- ⑤ **Timecode Rate indicator**  
Displays the current frame rate.
- ⑥ **STANDBY/ON button/indicator**  
Turns the unit on and standby. A system prompt will confirm shutdown. Holding the button down for several seconds will shut the unit off without a confirmation.
- ⑦ **System Lights**  
These indicators light when sample locked to an external source (**SAMPLE LOCK**), when in destructive

recording mode (**DEST REC**) and when using varispeed (**VARISPEED**).

- ⑧ **Display**  
This shows a variety of information.
- ⑨ **Optical drive**  
The internal DVD optical drive for backup, import and export of files.
- ⑩ **Transport buttons**  
See the Recorder chapter if you’re unsure how to use these.
- ⑪ **Enter button**  
Confirms menu selections. The Exit button is directly below it to cancel a menu option.
- ⑫ **Change button**  
Use this button to change a menu item in the Project, Sync, etc. menus.
- ⑬ **CLEAR/HOME button**  
When in menu mode, press this to return to the Home Screen display. Use this button also to clear a set value.
- ⑭ **Menu buttons**  
These access menu groups like Project, Sync, Preferences, etc. You can also change the input status, unmount a disk and more.
- ⑮ **▲/▼ buttons**  
Use these to scroll through menus and change their settings.

## 2 – Names and Functions of Parts

### Rear panel

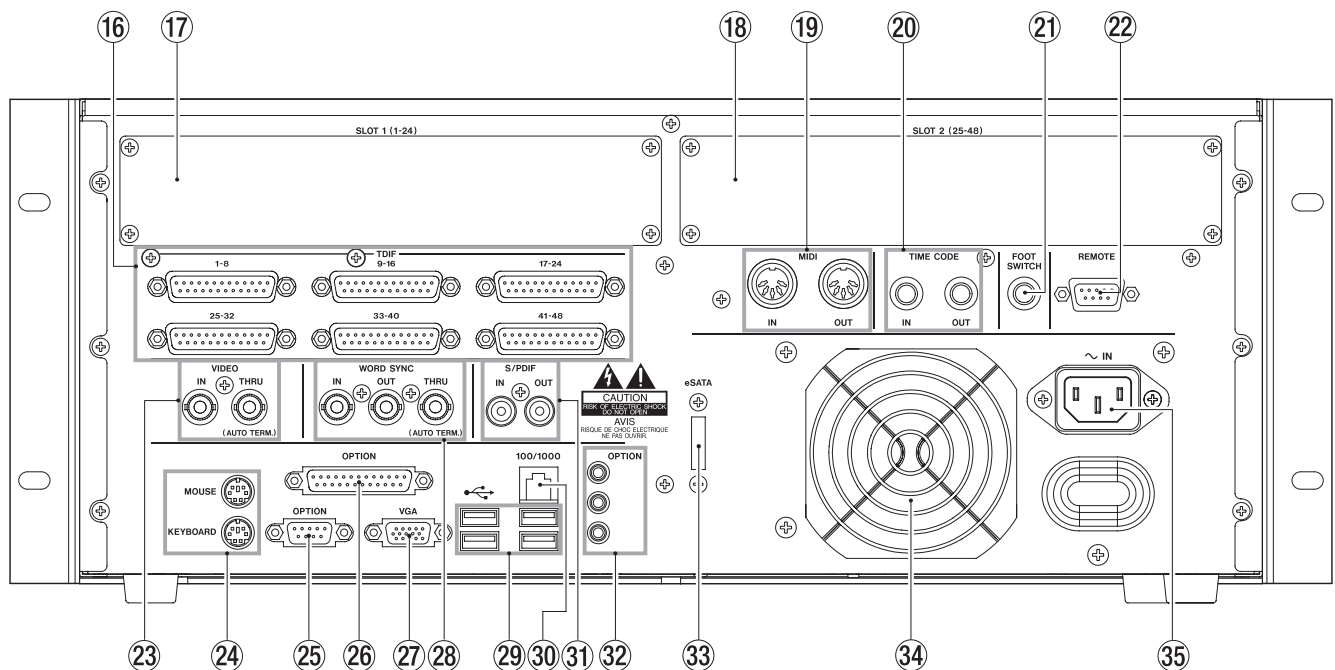

#### 16 TDIF Inputs and Outputs

Each of these jacks transmits 8 channels of TDIF-format digital audio input and output at up to 96 kHz/24-bit.

#### NOTE

To get all 8 channels of audio input and output at 96 kHz, the equipment connected to the X-48MKII must have the latest TDIF capabilities, such as TASCAM's DM-3200 and DM-4800 digital mixers.

#### 17 Option card slot 1

This slot adds an additional I/O format for channels 1-24. It's compatible with interface cards such as the IF-AN24X analog, IF-AD24 ADAT optical and IF-AE24 AES/EBU cards (sold separately).

#### 18 Option card slot 2

Adds an additional I/O format for channels 25-48. Cards 1 and 2 do not need to be the same, you can mix and match Analog and AES for example.

#### 19 MIDI Input and Output

Used to generate and receive MIDI Timecode. Also used to receive MIDI Machine Control commands.

#### 20 Timecode Input and Output

Generates and receives SMPTE LTC timecode through balanced 1/4" jacks.

#### 21 Footswitch jack

Compatible with a momentary footswitch like the TASCAM RC-30P for punch in/punch out and so on.

#### NOTE

To operate correctly, a footswitch must be connected before the X-48MKII is powered on.

#### 22 Remote

Compatible with RS-422 / Sony 9-pin edit controllers for machine control

#### 23 Video clock in/thru

Use these BNC connectors to input black burst and tri-level sync signals and for thru output.

#### 24 Mouse/Keyboard

PS/2-compatible mouse and keyboard inputs. You can also use a USB mouse and keyboard.

#### 25 Option

Not used.

#### 26 Option

Not used.

#### 27 VGA output

Your monitor should be capable displaying a resolution of at least 1024x768 pixels at a refresh rate of at least 60 Hz. The maximum resolution of the X-48MKII's display output is 2048x1536 pixels.

#### 28 Word Sync In/Out/Thru

Compatible with BNC word clock generators.

#### 29 USB

Four USB 2.0 jacks for connecting a keyboard, mouse, flash drive or hard drive.

#### 30 Ethernet

100/1000 (Gigabit compatible) ethernet jack. See the section on Networking for more information.

#### 31 S/PDIF

Stereo coaxial digital input and output.

#### 32 Option

Not used.

#### 33 eSATA

eSATA connector for connecting external hard drives

## 2 – Names and Functions of Parts

- ③④ **Cooling fan**  
Make sure that this fan is not blocked off in a rack to prevent overheating the system.
- ③⑤ **AC-IN jack**  
Connect the included power cord here.

# 3 – Setup

## I/O Card Installation

I/O cards of different types may be installed in the X-48MKII simultaneously. For example, an X-48MKII may have one analog card and one digital card installed, with independent I/O routing. Each X-48MKII option card provides 24 channels of input and output.

### CAUTION

To install an I/O card, please contact the retailer where you bought the unit or TASCAM support.

## Making Connections

You may not use all the connections provided on the rear of the X-48MKII, but they are there if you need them. Just skip over the sections below that don't apply to your setup. For further information on routing to and from these connectors, please refer to Section 'I/O Settings' (page 20).

### CAUTION

Before connecting or disconnecting anything to a connector, turn OFF the power of this unit and the devices being connected (particularly, with VGA and similar connections). Failure to do so could cause this unit or connected equipment to be damaged.

## TDIF

The X-48MKII comes standard with six DB25 connectors, each one capable of carrying eight channels of I/O at normal sample rates (44.1k, 48k) or double speed sample rates (88.2k, 96k).

### NOTE

Eight channels of double speed sample rate I/O on a single TDIF connection is a new development for TASCAM recorders and mixers. Please ensure that the equipment you are connecting the X-48MKII to will support this by contacting the manufacturer of that equipment.

### CAUTION

Use only cables that are specified by the manufacturer as "TDIF" cables. Using incorrect cables can damage your equipment.

## S/PDIF

The X-48MKII comes standard with two RCA jacks for S/PDIF I/O at both normal and double speed sample rates.

### CAUTION

To ensure clean data transmission, use only cables specified by the manufacturer as "S/PDIF" cables.

## AES/EBU

When installed into an X-48MKII Slot, an AES/EBU digital I/O card (TASCAM IF-AE24X) will provide 24 channels of I/O at normal sample rates (44.1k, 48k) or double speed sample rates (88.2k, 96k).

The AES/EBU DB-25 pinout is pictured :

### CAUTION

Use only DB25 cables specified by the manufacturer as "AES/EBU" cables. Many cables look the same on the outside.

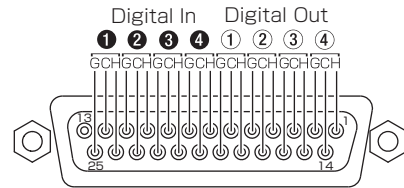

## ADAT

When installed into an X-48MKII slot, an ADAT digital I/O card will provide 24 channels of I/O at normal sample rates (44.1k, 48k).

## Digital Audio Clock

Any time multiple digital audio devices are connected together, or multiple digital audio connections are used simultaneously on a single device, all the digital audio clock rates of the connected devices must be locked together. If this is not done, or if it is done incorrectly, clicks, distortion, or muted audio may result. The X-48MKII may act as the master clock to other devices in a system, or it can lock its clock to an external device.

This section will only deal with the physical connections to achieve clock lock. For system configuration, please refer to 'Digital Audio Clock' (page 19). Note that all digital audio clock related connections may be connected simultaneously, with the needed one selected in the user interface.

If the X-48MKII is digitally connected to only one other device, the clocks may be locked via that connection, requiring no other connection be made.

## Word Clock

If the X-48MKII is digitally connected within a system of more than two digital devices, it is recommended to use Word Clock from one master source, distributed to all devices. The X-48MKII's rear panel **BNC Word Clock** connectors have the following uses:

- IN** This connector receives word clock from another device. When used, the X-48MKII should be configured to *Lock to Word Clock*.
- OUT** This connector transmits word clock to other devices. When used, the X-48MKII should be configured to *Internal Clock*.

**THRU** This connector passes the Word Clock signal present at the **Word Clock IN** through without adding any delay. This allows additional devices to be locked in a daisy-chain fashion in configurations where there is no way to directly distribute clock from a single source.

## Analog Audio

The IF-AN24X provides 24 channels of balanced analog inputs and 24 channels of balanced analog outputs. The X-48MKII can be configured to one of five possible operating reference levels by applying the appropriate software settings. Please refer to 'Analog I/O Operating Level' (page 20) for details.

The analog DB-25 pinout is pictured below:

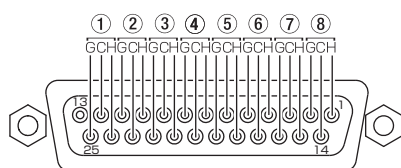

### CAUTION

Use only DB25 cables specified by the manufacturer as "Analog" cables. Many cables look the same on the outside.

## Synchronization and Control

This section will deal with the physical connections needed in various synchronized applications. For details about the appropriate software settings, please refer to the 'Synchronization' section (page 35).

### MIDI

There are two **MIDI connectors** on the rear of the X-48MKII. These are used for MIDI Machine Control (MMC) and MIDI Time Code (MTC).

- IN** This connector receives MTC, which the X-48MKII can chase, or MMC, which the X-48MKII can respond to. The front panel **MIDI LED** will illuminate when valid MIDI signals are present at this connector.
- OUT** This connector outputs MTC any time the transport is in motion. That MTC output follows the frame rate and output options set for LTC output. MIDI machine control (MMC) open loop and closed loop are supported.

## Time Code

There are two **1/4" TRS connectors** on the rear of the X-48MKII, used for sending and receiving time code (LTC). These connectors are balanced to allow for long cable runs with minimal interference. Please refer to pages 37-40 for details on time code options.

## Footswitch

A momentary footswitch may be connected to this **1/4" TS connector** for hands free play, stop, and punch-in/out operation.

### NOTE

To operate correctly, a footswitch must be connected before the X-48MKII is powered on.

## Remote (Sony 9-Pin)

This is also known as "P2" or "Sony P2" or "RS-422". Various recording consoles and video controllers support this protocol for transport control and track record enable. This requires a specifically constructed cable. If in doubt, pre-made RS-422 cables are readily available.

| Pin No. | Controlling end | Non-controlling end |
|---------|-----------------|---------------------|
| 1       | GND             | GND                 |
| 2       | RX-             | TX-                 |
| 3       | TX+             | RX+                 |
| 4       | TX common       | RX common           |
| 5       | Spare (NC)      | Spare (NC)          |
| 6       | RX common       | TX common           |
| 7       | RX+             | TX+                 |
| 8       | TX-             | RX-                 |
| 9       | GND             | GND                 |

## Video Reference (Tri Level Sync)

**IN** When the X-48MKII is used in a film/video post production environment, it may be necessary to resolve a consistent sample range with the time code edge. A video reference (blackburst) signal applied to this connector makes this possible. Please refer to page 19 for details on configuring the use of signals present at this connector.

Tri Level Sync is the video reference signal used for High Definition Video. This connector automatically senses the type of signal present.

**THRU** The video reference signal present at the **IN connector** is passed through out this connector without additional processing delay. This allows for daisy-chaining another device, after the X-48MKII, which requires a video reference signal.

## 3 – Setup

---

### Keyboard, Mouse & Monitor

A standard PC keyboard and mouse (or trackball) may be connected to the **P/S2** or **USB ports** on the rear of the X-48MKII. To take full advantage of these peripherals, it is recommended that a full keyboard with numerical keypad and a scrolling wheel mouse be used.

Your monitor should be capable displaying a resolution of at least 1024x768 pixels at a refresh rate of at least 60 Hz. The maximum resolution of the X-48MKII's display output is 2048x1536 pixels.

#### NOTE

The extra controls present on some multimedia keyboards, such as media player transport controls, are not supported by the X-48MKII. Similarly, a mouse or trackball that depends on the installation of custom driver software is not supported by the X-48MKII.

---

### Network

This unit has a 100/1000 (gigabit) port as a network connector (Ethernet).

You can use the unit's software to configure it.

Network cable used for the port should be minimally CAT-5. While network hubs and switches can be used with the X-48MKII, such devices may reduce network throughput, particularly on a network with much traffic.

To use the preinstalled MX-View software to control a TASCAM MX-2424, you must set the IP address correctly. Otherwise, communication with the MX-2424 will fail.

For more details about software configurations to use the X-48MKII within a networked environment, please refer to 'Networking' (page 22).

---

### External Drives

External hard drives may be connected to the **eSATA** or **USB 2.0 ports** on the rear of the X-48MKII to be used as record destination or copy destination drives.

USB Flash Drives, "Thumb Drives", may be connected to an X-48MKII's **USB port**. Such drives can be useful as source drives for copying material onto the X-48MKII's drive, copy destination drives for moving material off an X-48MKII, or for software updating. It is not recommended to record directly to such a drive due to their slow write speeds.

External optical drives (DVD, CDR, CDR/W) are not supported.

#### CAUTION

When recording to any external drive, it is strongly recommended to run the Drive Benchmarking utility to ensure the drive is fast enough for the desired number of record tracks. For example, while **eSATA** itself is fast enough for high track counts, the actual drive inside an external drive enclosure may be a low RPM drive, not capable of high track counts.

---

### Powering On / Standby

Now that things are connected, it's time to plug in the X-48MKII and power it on.

Momentarily press the **STANDBY/ON** button on the front panel and the X-48MKII will boot up. The boot process takes about 1 1/4 minutes to complete. When ready, the X-48MKII will display its track screen on a connected VGA monitor and the currently loaded project with time code on the front panel LCD display.

To power off the X-48MKII, either select *Shutdown* from the *File* menu in the VGA UI or momentarily press the front panel **STANDBY/ON** button. In either case, you will be prompted to save the currently loaded project then confirm the shutdown.

#### NOTE

Disconnect all USB flash drives before starting the unit. Starting the unit with a USB flash drive connected could prevent the unit from functioning properly. If this should happen, follow these procedures.

- 1) When the *Press F1 To Continue* prompt appears, press the F1 key on the keyboard.
- 2) Disconnect the USB flash drive.  
After disconnecting the USB flash drive the unit might restart 2–3 times to restore its ordinary state.

---

### External Applications

#### CAUTION

While the X-48MKII is based on PC/Windows architecture, it is not configured for general PC use. The Windows Embedded operating system used on the X-48MKII does not include general use components. We strongly advise you not to install non-qualified software on the X-48MKII. Doing so could lead to undesirable results, including X-48MKII malfunction, requiring you to use the X-48MKII System Restore CD to restore it to its original factory configuration.

---

### MX-View

Pre-installed on the X-48MKII is MX-View Version 1.40, for control of any existing MX-2424 machines you may have. For MX-View operational instructions, please refer to the MX-View Manual.

---

### TASCAM Mixer Companion

Pre-installed on the X-48MKII is TASCAM Mixer Companion Version 1.50. This allows the X-48MKII to act as the host computer for TMC when connected via USB to a TASCAM DM-3200 or DM-4800 digital mixer.

TMC updates may be installed by running the TMC update installer by selecting *Launch External Application* from the X-48MKII's *File* menu. The TMC update installer would have



to be on a piece of media that the X-48MKII has access to, such as a CD or USB flash drive.

**CAUTION**

Only Version 1.50 or higher (Windows version) is designed to operate on the X-48MKII. Earlier versions of TMC should not be installed on the X-48MKII.

---

## Using the X-48MKII System Restore CD

---

In the event it becomes necessary to use the X-48MKII System Restore CD to restore your X-48MKII to its original factory configuration, following the steps below will ensure a smooth restore process:

- 1 Back up all audio data. This should already be done as part of a regular workflow.**
- 2 Check the TASCAM website (<http://tascam.com/>) for the latest firmware and patch updates. If any are available, download them and use them to update the unit after using the System Restore CD to reinstall the system.**
- 3 With the X-48MKII powered on, insert the System Restore CD then restart the X-48MKII. The VGA UI doesn't have to be displayed, all that is required is power to open the drive tray. If necessary, the X-48MKII can be forced to shut down by holding the front panel power button for a few seconds.**
- 4 The X-48MKII will automatically boot from the System Restore CD and run the X-48MKII Installer. Please follow the steps in the X-48MKII Installer screens.**

**CAUTION**

When using the included System Restore CD to reinstall the system, always disconnect all external hard disks connected by eSATA or USB, including USB flash drives. Failure to do so will result in the System Restore CD erasing all data on these external hard disks.

**NOTE**

When formatting you can select whether to format only the OS partition (Windows XP Embedded and the X-48 Application) and rewrite the software or to also format the data partition at the same time.

# 4 – Configuration

This section helps you with the software settings you'll need to make in order for the X-48MKII to work smoothly in your application.

## Display Settings

Your monitor should be capable displaying a resolution of at least 1024x768 pixels at a refresh rate of at least 60 Hz. The maximum resolution of the X-48MKII's display output is 2048x1536 pixels. You change the display resolution from the *Windows* menu.

### NOTE

Resolution depends on the resolution of the connected display.



Mouse/Keyboard Operation

- 1 Click the *Windows* menu and select *Display Settings...*
- 2 Move the slider to change the display resolution (the minimum resolution is 1024 x 768) and press *Apply*.

## Setting the date and time

Set the built-in clock for accurate timestamping.



Mouse/Keyboard Operation (only)

Select *Set Date and Time* from the *File* menu, and set the date and time.

## Navigating the LCD Interface

To access menus and settings from the X-48MKII front panel, use the six buttons directly below the LCD display.

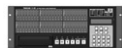

Front Panel Operation

- 1 Press one of the seven menus on the bottom right corner of the unit: **PROJ**, **DISK**, **INP 1-24**, **INP 25-48**, **SYNC**, **PREF** or **SYS**. See below for an explanation of each of these menus.
- 2 Press the **▲/▼** buttons to scroll through menus.
- 3 When you find a setting you want to edit, press **CHNG** (Change).
- 4 Press the **▲/▼** buttons to choose a setting.
- 5 When you're finished, press **ENTER** to save or **EXIT** to cancel your edit.
- 6 At any time, you can press **HOME** to get out of the menu system and back to the main screen.

The seven menu keys are used to access the following functions:

- PROJ** Goes directly to the list of project management functions such as **NEW**, **OPEN**, **SAVE**, **SAVE AS**, **Delete** and **COPY**.
- DISK** Goes directly to the list of hard drive management functions such as a **Free Space** display and disk formatting utility.
- INP 1-24** Goes directly to input routing menus for inputs 1 through 24. In most cases, these will be left at their default settings since much output routing can be done from a recording console. The choices presented in this menu allows the use of consoles with less than 48 outputs.
- INP 25-48** Goes directly to input routing menus for inputs 25 through 48. In most cases, these will be left at their default settings since much output routing can be done from a recording console. The choices presented in this menu allows the use of consoles with less than 48 outputs.
- SYNC** Goes directly to the list of synchronization settings and functions such as time code frame rate, digital audio clock settings and time code chase options.
- PREF** Goes directly to a list of general operating preferences for the X-48MKII such as transport options, pre/post roll options, front panel UI options and external control options.
- SYS** Goes directly to a list of system settings such as save/load of user configurations and network settings.

## Sample Rates

The X-48MKII supports the base sample rates of 44.1k, 48k, 88.2k and 96k. The sample rate for your project should be set immediately after creating the project and before recording any audio. New projects will be created at the currently set sample rate by default. A project's sample rate is stored as part of the project.

If a project's sample rate is changed after recording audio into that project, a confirmation dialog will be presented. Proceeding with the sample rate change will cause the project to play back faster or slower than it was originally recorded.

You will notice many other sample rates in the list besides the four noted above. Those are "pull up" and "pull down" rates for use in film and video applications. This will be covered in 'Synchronization' (page 35).

To set the sample rate:



Mouse/Keyboard Operation

- 1 **Click on the *Windows* menu and choose *Settings...***
- 2 **Click on the *Sync* tab.**
- 3 **Click on the *Rate* pull-down menu under *Sample Clock*.**
- 4 **You will see the currently selected sample rate with a check mark. Select another sample rate by clicking on it.**



Front Panel Operation

- 1 **Press SYNC.**
- 2 **Use the ▲/▼ buttons until you see Sa mple Rate.**
- 3 **Press CHNG.**
- 4 **Use the ▲/▼ buttons until you see your desired sample rate.**
- 5 **Press ENTER/YES.**
- 6 **When Cha nge Sa mple Rate OK? appears, press the ENTER/YES button.**

## Digital Audio Clock

When digitally connected, two or more pieces of audio equipment must be running at exactly the same digital audio clock rate and have their sample exactly lined up. If this is not done, audio artifacts like clicking and popping or completely muted audio will result.

The X-48MKII provides the ability to operate in many digital audio clock scenarios. Each available setting is shown below along with an example of why it may be used. These settings are made on the *Sync* tab of the *Settings* window.

### Internal

When selected, the X-48MKII's digital audio clock is running on its own at the selected sample rate. Choose this when the X-48MKII is connected to an analog mixer or when the X-48MKII is the clock master for other pieces of digital audio equipment.

### Varispeed

The term "varispeed" refers to a recorder's ability to run faster or slower than a base rate. This may be used to record off speed for later playback at normal speed for a special effect. It can also be used to slightly alter the pitch of a recording for tuning purposes. Varispeed is only available when the X-48MKII is set to *Internal clock*. When clocked externally, the X-48MKII must follow the rate of that external clock.

### Word Clock

When selected, the X-48MKII's digital audio clock will be locked to any word clock signal present at its **BNC Word**

**Clock input.** If this is selected, but no word clock signal is present, the sample rate indication in the GUI and the **Sample Lock LED** on the front panel will flash indicating no clock lock.

Word clock is commonly used when many pieces of digital audio gear are connected together in a system and clock is correctly distributed from a central clock generator or one of the connected devices.

### Invert Word Out Polarity

Some manufacturers of digital audio equipment lock to the rising edge of a clock signal while others use the falling edge. This setting allows the X-48MKII to operate as a clock master with either type of equipment. This may not be documented by all manufacturers, so if your clock configuration appears correct but you are still hearing artifacts such as clicks, try changing the value of this setting.

### Clock Rate Multipliers

Some older word clock generators only support base clock rates (44.1k, 48k). For scenarios where such a clock generator is used in a system running at higher clock rates, the X-48MKII provides the ability to lock to, and output, word clock rates that are exact multiples of its operating rate. For example, a system may be running at 96k, but the clock generator's maximum output rate is 48k.

### ADAT Card/AES Card (1, 2)

When selected, the X-48MKII's digital audio clock will be locked to the digital audio signal present at the first group of eight inputs of a digital I/O card installed in the specified slot. This would typically be used when the X-48MKII is digitally connected via one of its slots to one other piece of equipment such a mixer or another recorder.

### S/PDIF

When selected, the X-48MKII's digital audio clock will be locked to the digital audio signal present at the rear panel **S/PDIF input**. This would typically be used when the X-48MKII is digitally connected to the **S/PDIF output** of a piece of equipment when transferring stereo audio into the X-48MKII. On the *SETTINGS* screen *I/O* tab, set *S/PDIF output mode* to *Professional* (*Professional Mode* check box checked) or *Consumer* (*Professional Mode* check box unchecked).

### TDIF Port 1

When selected, the X-48MKII's digital audio clock will be locked to the digital audio signal present at the first TDIF port (1-8). This would typically be used when the X-48MKII is digitally connected via TDIF to one other piece of equipment such as a mixer or another recorder.

### Resolve to Video In

When checked, the X-48MKII will align the frame edge of its timecode with the edge of the video reference signal. This is not used as a sample clock source. Check this box when the X-48MKII is synchronized via time

## 4 – Configuration

code to devices such as video recorders, cameras, or edit controllers and all devices are locked to the same video reference signal (a.k.a. black burst). For more information on synchronization and working with film or video, please see the “Video Clock Frame-Edge Resolve” section on page 37 in chapter 5.

---

### I/O Settings

---

This section explains how to configure the optional I/O cards for the X-48MKII.



#### Mouse/Keyboard Operation

Choose *Settings* from the *Windows* menu and click on the *I/O* tab.

#### I/O Cards

At the top of the display, you will see a list of installed optional I/O cards (if any).

#### I/O Setup

Using the *I/O Card Select* menus, you can select *Input* and *Output* types in groups of eight from the selection pull down menus. (They are all set to *TDIF* by default.) The *Input Routing* pull down menus set track input sources in groups of eight. They can be used to configure the recorder inputs for a console that has less than 48 routing outputs. For example, a console with 24 TDIF outputs could be connected to the X-48MKII this way:

- 1 **Connect console TDIF outs 1-24 to X-48MKII TDIF in 1-24.**
- 2 **Set *Input Routing* for channels 1-8 and 25-32 as *Input Grp 1* 1-8.**
- 3 **Set *Input Routing* for channels 9-16 and 33-40 as *Input Grp 2* 9-16.**
- 4 **Set *Input Routing* for channels 17-24 and 41-48 as *Input Grp 3* 17-24.**

This allows all 48 tracks to receive signal without physical re-patching. Console out 1 will feed track 1 and 25, console out 2 will feed tracks 2 and 26, etc. There is a track-by-track input selection pull down menu in the *TRACK* screen which over-rides the selection made in the *Settings* window.

You can also select the *I/O operating level* from the pulldown menu at the bottom of the window. See the next section for more information.

#### S/PDIF

Use the *Sample rate conversion on S/PDIF inputs* checkbox to set whether or not the S/PDIF input sampling rate is converted or not.



#### Front Panel Operation

To configure the **I/O cards** from the front panel:

- 1 **Press the INP 1-24 or INP 25-48 key.**
- 2 **Use the ▲/▼ buttons to select a bank of 8 inputs and outputs, i.e. “IO Card Select 1-8,” and press CHNG.**
- 3 **Select either TDIF 1-8 or Slot 1 (1-8) and press ENTER.**
- 4 **Press the EXIT button when you are finished changing physical I/O types.**

To send a different bank of inputs to tracks, for example send inputs 1-24 to 25-48 (see example above):

- 1 **Press the INP 1-24 or INP 25-48 key.**
- 2 **Use the ▲/▼ buttons to select routing for a bank of tracks, such as “Input Routing 25-32,” and press CHNG.**
- 3 **Select a bank of inputs, i.e. Input Grp 1 1-8, and press ENTER.**
- 4 **Press the EXIT button when you are finished changing input groups.**
- 5 **Press the CLEAR/HOME button to return to the Home Screen.**

---

### Analog I/O Operating Level

---

You can set the analog operating level from the *Settings* menu. Choose *Settings* from the *Windows* menu, click the *I/O* tab and click the *I/O Operating Level* from the pull-down menu. The levels (in dBFS) that can be selected are 20dB, 18dB, 16dB, 14dB and 9dB.

---

### Control Mode

---

This unit has the following four transport control modes, which can be set on the *SETTINGS* screen. From the *Windows* menu, select *Settings* and click the *Sync* tab. In the *Time Code* section, use the *Control Mode* pull-down menu to select the desired control mode.

#### Internal

Use this mode to run the unit following its own timecode.

#### SMPTE

When enabled and the front panel **TC CHASE** key is enabled, the X-48MKII chases the SMPTE timecode from its input jack.

#### MIDI (MTC)

In this mode with the front panel **TC CHASE** key enabled, the X-48MKII chases incoming MIDI timecode from its **MIDI input**.

#### Theater Play

This is a special playback mode similar to Auto Cue on a CD Player. Please refer to page 38 for details on the use of this mode.

## MIDI Device ID

When working with MIDI Machine Control, you can set a MIDI device ID so that other devices do not intercept commands for the X-48MKII (and vice-versa).

To set the MIDI device ID:



Mouse/Keyboard Operation

- 1 Click the *Windows* menu, select *Settings* and click the *System* tab.
- 2 Click the *MIDI Device ID* pulldown.
- 3 Select a device ID from the list.



Front Panel Operation

- 1 Press the **SYS** button.
- 2 Press the **▲/▼** buttons to select *Midi Device ID* and press **CHNG**.
- 3 Select an ID and press **ENTER**.
- 4 Press the **CLEAR/HOME** button to return to the Home Screen.

## Sony 9-Pin

This section explains how to control the X-48MKII using Sony 9-pin, also called P2 or RS-422.

### Track Arm

Setting it to *Digital/Console* allows you to arm tracks over 9-pin. Set this to *Local* if you don't want to arm tracks this way.

### Punch Delay

You can set the punch-in delay from off to 6 frames. This is used when it is necessary for the X-48MKII to emulate an older video deck to match what is expected by the controller.

### Chase Control

Choose *LTC (SMPT E)* or *MTC (MIDI)* or disable it here.

To access these settings



Mouse/Keyboard Operation

- 1 Click the *Windows* menu and select *Settings*.
- 2 Click the *Prefs* tab.
- 3 There are three settings under the *Sony 9-pin* heading: *Track Arm*, *Punch Delay* and *Chase Control*.



Front Panel Operation

- 1 Press the **PREF** button.
- 2 Press the **▲/▼** buttons to select *P2 Track Arm*, *P2 Punch Delay* or *P2 Chase Control* and press **CHNG**.

## Video Reference

When working in video, use video black burst to align your audio playback and time code to exactly a frame edge.

To switch on video reference:



Mouse/Keyboard Operation

- 1 Click the *Windows* menu and choose *Settings*.
- 2 Select the *Sync* tab.
- 3 Check the box labeled *Resolve to Video In*.



Front Panel Operation

- 1 Press the **SYNC** button.
- 2 Press the **▲/▼** buttons to select *Resolve to Video In* and press **CHNG**.
- 3 Use the **▲/▼** buttons to select **0** and press **ENTER**.

The Video Clock input supports Tri-Level Sync for High Definition Video. If the black burst input is Tri-Level, the X-48MKII automatically enables this feature. See Chapter 5, Recorder, for more on sample clock and video sync.

## Pull Up/Pull Down Sample Rates

The X-48MKII supports pull-up and pull-down sample rates for use in film and video post-production. When you select the sample rate for the new session, be sure to consider the final delivery format and set your sample rate accordingly. See Chapter 5, Recorder for more on sample rates.

## 4 – Configuration

### Networking

The X-48MKII can be connected to a computer using the fast **Gigabit Ethernet connection**. You need an Ethernet crossover cable to connect your computer to the X-48MKII, unless you know that your computer's Ethernet connector is "auto-sensing" (such as most modern Apple computers). Once the ethernet cable is connected, you need to configure both the X-48MKII and your PC for networking.

To configure the X-48MKII for networking:



#### Mouse/Keyboard Operation

- 1 **View the *Settings* window, *System* tab.**
- 2 **Press the *Configure* button.**
- 3 **Select *Use the following IP address*.**
- 4 **Set *IP address* to be 192.168.1.1. If this address is already in use by your router, choose a different number for the last digit.**
- 5 **Set *Subnet mask* to be 255.255.255.0.**
- 6 **Leave the *Default gateway* blank.**
- 7 **Use the following *DNS server addresses* should be selected already.**
- 8 ***Preferred DNS server* and *Alternate DNS server* should be blank.**
- 9 **Press *OK*.**
- 10 **Begin sharing the X-48MKII's hard drive by selecting *Drive Sharing...* from the *File* menu.**

To configure your Windows XP computer for networking to the X-48MKII:

#### NOTE

Before starting the following procedures, you must launch the Windows file manager from the X-48 *Disk Management* menu, and enable sharing of the relevant folder (right click the relevant folder, select the *Properties* menu item and open the *Sharing* tab to make this setting).

- 1 **Select *Start->Control Panel->Network Connections*.**
- 2 **You should see a list of network connections, with one called *Local Area Connection*.**
- 3 **Right-click on *Local Area Connection* and select *Properties*.**
- 4 **Click on *Internet Protocol (TCP/IP)* so that it is highlighted. (Its check box must remain checked.)**
- 5 **Press the *Properties* button.**
- 6 **Select *Use the following IP address*.**
- 7 **Set *IP address* to 192.168.1.2. (Note: This is different from the X-48MKII's IP address.) If this IP address is already in use on your network, pick a different number for the last digit.**
- 8 **Set *Subnet mask* to be 255.255.255.0.**
- 9 **Leave the *Default gateway* blank.**

- 10 **Use the following *DNS server addresses* should be already selected.**
- 11 ***Preferred DNS server* and *Alternate DNS server* should be blank. Press *OK*.**
- 12 **Close the *Local Area Connection Properties* window.**
- 13 **Select *Start->My Network Places*.**
- 14 **On the left side of the *My Network Places* window is a list of *Network Tasks*.**
- 15 **Select *View workgroup computers*. If this left side display is not visible, enable it by going to *Tools > Folder Options > General* tab and click *Show common tasks in folders*. Alternatively, you could double click *Entire Network* then *Microsoft Windows Network* to see the available workgroups. Inside the workgroup named *Workgroup* will be the X-48MKII. If your computer and X-48MKII workgroup names are different, navigate one level up to see all the workgroups present on the network and look inside *WORKGROUP* to find the X-48MKII.**

Your X-48MKII will show up similar to this: "X48-uo0t97er5vk". (It is possible that you may need to wait a minute or so for the X-48MKII to show up in this list.)

#### NOTE

Note that the X-48MKII's workgroup name is fixed as *WORKGROUP*. Your PC's network name may not be *WORKGROUP*. For example, Windows XP Home has a default network name of *MSHOME*. To find the workgroup name of your computer go to *Control Panels > System > Computer Name* tab.

- 16 **Double click on the icon that represents the connected X-48MKII.**
- 17 **You should be prompted to enter a user name and password.**
- 18 **The user name is "administrator" and the password is "admin".**
- 19 **Now when you double click on the icon, you should be able to see the X-48MKII's internal hard drive. It is called "X48 Data Drive".**
- 20 **Double-click on *X48 Data Drive* to see its contents.**
- 21 **Look in the *XProjects* directory for projects.**

To configure your Mac OS X computer for networking to the X-48MKII:

- 1 **Click on *System Preferences...* under the *Apple* menu and choose *Network*.**
- 2 **(Optional:) You may want to make a new *Location* under the *Location* pull-down menu.**
- 3 **Double-click on *Built-In Ethernet*.**
- 4 **Click the *Configure IPv4* pull-down menu and choose *Manually*.**
- 5 **Set *IP Address* to 192.168.1.2. (Note: This is different from the X-48MKII's IP address.) If this IP address is already in use on your network, pick a different number for the last digit.**

- 6 Set *Subnet Mask* to be 255.255.255.0.
- 7 Leave *Router*, *DNS Servers* and *Search Domains* blank.
- 8 Click *Apply Now* and close the window.
- 9 Open a new **Finder** window and click the *Network globe* on the left side of the window.
- 10 Your X-48MKII will show up similar to this: “X48-uo0t97er5vk”. (It is possible that you may need to wait a minute or so for the X-48MKII to show up in this list.)
- 11 Double click on the icon that represents the connected X-48MKII.
- 12 You should be prompted to enter a user name and password. The user name is “*administrator*” and the password is “*admin*”.
- 13 The Finder will ask you which drive you want to mount. There is only one choice, “*X48 Data Drive*”. Click **OK**.
- 14 Double-click on *X48 Data Drive* to see its contents.
- 15 Look in the *XProjects* directory for projects.

If you're having trouble getting things to work, you should be able to “ping” the X-48MKII from the PC. Open an MS-DOS window (Windows) or the Terminal in Applications/Utilities (Mac OS X) and type “*ping 192.168.1.1*”. Note that this example uses the IP address specified in the above steps. If the X-48MKII does not respond then something is not connected or configured correctly.

You can change this unit's network name. This is the name shown on a computer connected to the unit by a network. To change this name, click *Set X48 Name* in the *File* menu shown on the display connected to the unit.

## Checking Free Hard Drive Space

Prior to beginning a recording project, you'll probably want to check your available hard drive space.



Mouse/Keyboard Operation

- 1 Click the *Options* menu *Disk Usage Display* item.
- 2 When *Disk Usage* is selected, the hard disk usage (%) is shown to the left of the CPU meter on the connected display.  
When *Record Time Remaining* is selected, the amount of recording time possible for the set *Rec Track* number is shown.



Front Panel Operation

- 1 Press the **DISK** button
- 2 Use the **▲/▼** buttons to select **Free Space**, and press **CHNG** button.

- 3 Press the **▲/▼** buttons to see the free space on each of your drives.
- 4 Press **HOME** when you're finished.

## Drive Benchmarking Utility

The X-48MKII includes a utility that you can use to test any connected drive before using it. The recorder runs a series of write/read tests and then reports how many tracks it can record to that drive disk for each sample rate by converting the transmission capability into numbers of tracks.

### NOTE

- The number of usable tracks cannot exceed 48.
- We recommend using this utility whenever you connect a new hard disk drive (particularly when connecting eSATA/USB external drive enclosures with unknown disks inside) and when recording in cold temperatures. (In cold temperatures, reading and writing speeds might be reduced.)

To run the Drive Benchmarking Tool:



Mouse/Keyboard Operation (only)

- 1 Click the *File* menu and choose *Drive Benchmarking...*
- 2 Choose your hard drive from the pull-down menu.
- 3 Click **OK** to start the test. In about a minute, the X-48MKII will report how many tracks you can record to this drive at 48 kHz and at 96 kHz.

### ■ Maintaining good hard disk performance

In order for this unit to write 48 tracks, which is a great amount of data, to a hard disk, the data transmission rate must be sufficient. To assure this, it is necessary to always keep hard disks in good condition. This is especially important when using external hard disk drives and when using 88.2 and 96 kHz “double” sampling rates.

In order to prevent errors caused by insufficient data transmission rates, please conduct the following maintenance operations regularly.

- If 3 or more projects have already been created on a single hard disk partition, erase all the projects and format that partition first before creating a new project on it.
- Before starting a long recording, format the hard disk and create a new project first.

### CAUTION

At around 0° C and below, hard drive performance decreases and the number of recordable tracks can be affected. Before undertaking important recording, check the drive performance using the *File* menu *Drive Benchmarking...* item. We also recommend testing recording for 1–2 minutes.

## 4 – Configuration

### ■ Recommended specifications for external hard drives

We recommend using external hard drives that have rotation speeds of 7200 rpm or more and a cache of 8 MB or more. Hard drives with lower specifications might not be able to handle the transmission of 48 tracks. Moreover, we highly recommend that you use the *File* menu *Drive Benchmarking...* item to check external hard drives regularly.

---

## Formatting a New Drive

---

A new hard drive needs to be formatted before recording on the X-48MKII. To do this:

 Mouse/Keyboard Operation

- 1 Click the *File* menu and choose *Disk Management...*
- 2 The X-48MKII warns you that it will shut down after running this application. Click *Yes* (or *No*) to save your project first.
- 3 The next prompt warns you that you can do some serious damage by misusing the Disk Management tool, such as modifying the C: drive. Click *OK* when you're ready to begin.
- 4 The Disk Management tool opens. *Disk0* should be the startup disk, partitioned into the C: drive (your operating system and program files), and the D: drive (the Data partition you can write to).
- 5 If you've connected an eSATA drive, you should see it mounted as *Disk1*. To format this disk, right-click the bar on the right and select *Format*.
- 6 Give the disk a name and click *OK* twice.
- 7 When you're finished, click the *Close* box in the top right corner. The X-48MKII will shut down. Restart the recorder to begin using your drive.

 Front Panel Operation

- 1 Press the **DISK** button.
- 2 Use the **▲/▼** buttons to select *Disk Format* and press **CHNG**.
- 3 Select a drive using the **▲/▼** buttons and press **ENTER**.
- 4 The display will ask you if you want to format the drive. Press **ENTER/YES**.

---

## Factory Defaults

---

This section tells you how to restore the X-48MKII to factory defaults.

 Mouse/Keyboard Operation

- 1 Open the *Windows* menu and select *Settings*.
- 2 Click the *System* tab.
- 3 Click the *System Settings Reset* button. The recorder will ask you if you want to restore the X-48MKII to factory settings, click *OK*.

 Front Panel Operation

- 1 Press the **SYS** button.
- 2 Press the **▲/▼** buttons until you select *Settings* and press **CHNG**.
- 3 Select *Recall Defaults* using the **▲/▼** buttons and press **CHNG**.
- 4 The display will ask, *Reset settings to factory defaults?* Press **ENTER/YES**.
- 5 Press the **CLEAR/HOME** button to return to the Home Screen.

---

## Store/Recall User Settings

---

You can store your own settings for later recall. You might do this if you do multiple types of sessions that require different configurations:

 Mouse/Keyboard Operation

- 1 Open the *Windows* menu and select *Settings*.
- 2 Click the *System* tab.
- 3 Click the *System Settings Store* button. Type a name for the settings and click *Save*.
- 4 To restore the system settings you've saved, click the *Recall* button and find your backup.

 Front Panel Operation

- 1 Press the **SYS** button.
- 2 Press the **▲/▼** buttons until you select *Settings* and press **CHNG**.
- 3 Select *Store...* using the **▲/▼** buttons and press **CHNG**.
- 4 Give your settings a name using the **▲/▼** buttons and the **CHNG** button to cursor forward, then press **ENTER/YES**.
- 5 To recall your settings, select *Recall...* from the previous menu and locate your backup file.



---

### Mixer Bypass

---

Bypassing the mixer section improves input to output delay and reduces CPU usage by keeping the mixer EQ, level, etc. settings disabled when using the X-48MKII strictly as a recorder. Mixer Bypass is switched on by default, so you will need to disable it before using the mixer section.

To access this setting:



Mouse/Keyboard Operation (only)

- 1 **Open the *Windows* menu and select *Settings*.**
- 2 **Select the *System* tab.**
- 3 **Check or uncheck the *Mixer Bypass* checkbox.**

---

### Make a Default Project

---

You can define a default project which has all of the routing and sync presets you typically use.

To do this:



Mouse/Keyboard Operation (only)

- 1 **Open the *File* menu and select *Save Project As...***
- 2 **Double-click *D:\XProjects* and *Startup* in order.**
- 3 **Name your project "*Startup*". Click *OK* to replace the old file.**

# 5 – Recorder

## Working With Projects

### Creating a New Project



Mouse/Keyboard Operation

- 1 Click on the *File* menu and select *New Project...* or press **Control-N** on the keyboard.
- 2 The display will ask you if you wish to save changes to the current project. Click on *Yes* or *No*.
- 3 The display prompts you for the following information:

#### Name

Type a name for the project using the keyboard

#### Drive

Select which drive to record to

#### Mode

Either *Non-Destructive* or *Destructive*. See next section for explanation.

#### Sample Rate

The sample rate for the session. Most users will choose either *44.1k* (CD-standard), *48k* (DVD-standard), *88.2k* (2x CD) or *96k* (2x DVD). A number of other sample rates are provided for post production use. See "Sample Rates" (page 18) for more information on when to use these sample rates.

#### Bit Depth

Choices of *16-bit*, *24-bit*, or *32-bit Floating Point* are provided.

- 4 Click *OK* when complete.



Front Panel Operation

- 1 On the front panel of the X-48MKII, press the **PROJ** button, press the **▲/▼** arrows to select **Ne** and press **CHNG**.
- 2 Press the **Yes** or **No** button to save the current project.
- 3 Choose a drive to record to with the **▲/▼** buttons and press **ENTER**.
- 4 Select the bit depth **16 Bit**, **24 Bit** or **Floating Point** and press **Enter**.
- 5 Give the project a name using the **▲/▼** buttons to change letters, the **CHNG** button to select the next letter. Press **Enter** to create the project or **EXIT** to cancel.

### Destructive versus Non-Destructive Recording

The X-48MKII provides two methods for recording, Non-Destructive (the default) and Destructive.

When Non-Destructive recording is selected, new recordings are written to the hard drive as new WAVE files. With this method, you can return to an old take of a recording using Undo or by editing the previous take. The disadvantage to this method is that your hard drive is filled with Wave files. If you imported all of these files into a digital workstation, you may not be able to tell which was the final approved recording unless you had exported an AAF file as well.

Using Destructive recording is just like using a multitrack tape, and is often referred to as "tape mode." If you look at the hard drive after recording this way, you will see one long WAVE file for every track that you recorded to. Film re-recording mixers use destructive recording to record their final mixes. As they punch in and out of their mix recorder all day, they only want one master file of the approved mix to encode into Dolby Digital or however it's being processed for release. Destructive recording also has the advantage that it uses less hard drive space, since old takes aren't kept. But just like the multitrack tape it emulates, when you record over something it's gone forever. There's no undo in destructive recording mode.

*DEST REC* is shown at the top center of the connected display, and appears lit when in destructive mode.

#### NOTE

This has the same meaning as the **DEST REC (SYSTEM)** indicator on the front panel.

### Opening a Project



Mouse/Keyboard Operation

- 1 Click on the *File* menu and select *Open Project...* or press **Control-O** on the keyboard.
- 2 The display will ask you if you wish to save changes to the current project. Click on *Yes* or *No*.
- 3 The *Open Project* window appears. At the top of this window, click the *Up* button to navigate up a level on your hard drive, or all the way up to see all drives connected to the system.
- 4 Double-click on the folder containing your project. You should see a project with the filename you chose ending in an *.ndr* extension. Double-click on this file to open the project.



## Front Panel Operation

- 1 On the front panel of the X-48MKII, press the PROJ button, press the ▲/▼ arrows to select **Open** and press CHNG.
- 2 Press the Yes or No button to save the current project.
- 3 Choose a folder.
- 4 Select the file/folder to open using the ▲/▼ buttons and press ENTER, or EXIT to cancel.

---

## Saving a Project



## Mouse/Keyboard Operation

- Click on the *File* menu and select *Save Project...* or press Control-S on the keyboard.



## Front Panel Operation

- On the front panel of the X-48MKII, press the PROJ button, press the ▲/▼ arrows to select **Save** and press CHNG.

### Saving Your Work

How often do you need to save? The X-48MKII writes data to the drive during recording. You should periodically save during recording, and whenever you change something in the mixer.

You may also want to switch on Auto Save, described below. During recording, however, audio clips are captured with Fail Safe recording, which updates the WAV file headers every 5 seconds.

For best results and peace of mind, save early and often.

---

## Auto-Saving Projects

You may want to enable auto-save so that your recordings and mixes are saved in the event of a power outage.



## Mouse/Keyboard Operation

- 1 Click on the *Windows* menu and select *Settings*, or press Alt-F8 on the keyboard.
- 2 Select the *Prefs* tab.
- 3 Click the *Auto-save Projects* checkbox. You can specify how often the machine saves, from every 1 to 120 minutes (10 minutes is the default).



## Front Panel Operation

- 1 On the front panel of the X-48MKII, press the PREF button.
- 2 Press the ▲/▼ arrows until you select **Auto Save** and press CHNG.
- 3 Press the ▲/▼ buttons to select **Off** and press ENTER.
- 4 Press the PREF button again, press the Up button once to select **Auto Save Time** and press CHNG.
- 5 Change the Auto-save interval time (10 minutes is the default) and press ENTER.

**NOTE**

Turn the Auto Save function OFF when using the unit only for playback.

---

## Importing a Project

The X-48MKII can import an Open TL project. This function can only be accessed from the mouse and keyboard. It is not possible to import a file using the LCD on the front panel.



## Mouse/Keyboard Operation (only)

- 1 To open this project, select *Import Project...* from the *File* menu.
- 2 The recorder will prompt you to save your project, click either *Yes* or *No*.
- 3 Select a project to import using the window interface. You can navigate up to select another drive. Click *Open* or *Cancel* to select a project.  
A progress bar appears while importing.

---

## Exporting a Project

The X-48MKII can export the recording project as either an AAF file (Advanced Authoring Format) or an Open TL file. AAF files are supported by most digital audio workstations, including Pro Tools, Logic and Nuendo. You may need additional software to import an AAF file, such as DigiTranslator for Pro Tools. Consult your workstations documentation or support website for more information. This function can only be accessed from the mouse and keyboard. It is not possible to import a file using the front panel LCD.



## Mouse/Keyboard Operation (only)

- 1 To open this project, select *Export Project...* from the *File* menu.
- 2 Using the *Filter* control at the bottom of the window, select either *AAF* or *Open TL* as your output format.

## 5 – Recorder

- 3 You can navigate up to select another drive. Click *Save* to export the project.

### ■ Exporting as an AAF file

When exporting as an AAF file, you can export as an embedded or non-embedded file. When you choose the *File* menu “Export Project...” item the export screen appears. On this screen, you can set whether to export an embedded AAF file or a non-embedded AAF file. The difference between embedded and non-embedded files is explained below.

- Embedded AAF files contain all the information and audio files for a project. In other words, the entire project can be stored in a single embedded AAF file (.aaf). The maximum size of a single AAF file, however, cannot exceed 2 GB. For this reason, if the total data of the project exceeds 2 GB (because it has many tracks and/or very long clips), you must export it as a non-embedded AAF. If you try to export a project that is larger than 2 GB as an embedded AAF, an error message will appear and exporting will be canceled.
- Non-embedded AAF files only contain the project information. When you export this way, a folder that contains all the audio files will also be created. As with embedded AAF files, the maximum size is 2 GB, but this limitation has no practical effect since non-embedded AAF files do not contain audio files.

---

### Copying a Project

You can make a copy of a project with the X-48MKII, for instance as a backup to another drive. This copies the project and all of its wave recordings, unlike *Save As...* which only copies the project file.



Mouse/Keyboard Operation

- 1 Click on the *File* menu and select *File Manager* or press **Ctrl-F** on the keyboard.
- 2 You should see the *File Manager* window with two panes on the left and right. In the left hand pane, navigate to the project folder you want to copy (containing the *.ndr* file and *Audio* folder). Click on this folder so it's highlighted.
- 3 Using the controls on the right side, navigate to where you want to copy the project to, i.e. a removable eSATA hard drive.
- 4 When you're ready to begin copying, press the **>>** button under the word *Copy* between the two panes.



Front Panel Operation

- 1 On the front panel of the X-48MKII, press the **PROJ** button, press the **▲/▼** arrows to select **COPY** and press **CHNG**.

- 2 Press the **▲/▼** arrows until you select a source project folder and press **ENTER**.
- 3 Press the **▲/▼** arrows and select a project file (*.ndr* file) and press **ENTER**.
- 4 Press the **▲/▼** arrows and select a destination drive and press **ENTER**.
- 5 Enter a destination project name by using **▲/▼** arrows and **CHNG** button, and press **ENTER**.

For details about how to copy projects in a connected network, see “Networking” on page 22.

---

### Backing Up a Project to CD/DVD

Use the built-in DVD drive to make a backup.



Mouse/Keyboard Operation (only)

- 1 Click on the *File* menu and select *File Manager* or press **Control-F** on the keyboard.
- 2 You should see the *File Manager* window with two panes on the left and right. In the left hand pane, navigate to the project folder you want to back up (containing the *.ndr* file and *Audio* folder). Click on this folder so it is highlighted.
- 3 In the center pane, click the *Backup* button.
- 4 The *Burn Options* window should appear. It will tell you how large the project folder you selected is, and will give you the option to burn the project to a **650MB CD**, **700MB CD** or **4.7GB DVD**. You can also click a checkbox to verify the disk after it has been burned.

#### NOTE

- Backups can only be made using the built-in DVD drive or a different hard disk.
- Only one project can be backed up at a time.

---

### Deleting a Project



Mouse/Keyboard Operation

- 1 Click on the *File* menu and select *File Manager* or press **Control-F** on the keyboard.
- 2 You should see the *File Manager* window with two panes on the left and right. In the left hand pane, navigate to the project folder you want to delete (containing the *.ndr* file and *Audio* folder). Click on this folder so it's highlighted.
- 3 In the center pane, click the *Delete* button.
- 4 In the *Confirm Delete* window that opens, click **OK**.



## Front Panel Operation

- 1 On the front panel of the X-48MKII, press the **PROJ** button, press the **▲/▼** arrows to select **Delete** and press **CHNG**.
- 2 Press the **▲/▼** arrows to select a project folder and press **ENTER**.
- 3 Press the **▲/▼** arrows and select a project file (file) and press **ENTER**.
- 4 A confirmation message appears. Press **YES/NO** to execute/cancel the delete operation.

---

## Load Last Project

The X-48MKII can default to loading the last project used at startup. This is useful for working on long-term projects, or when the X-48MKII is used as a playback device for live or theater use.



## Mouse/Keyboard Operation

- 1 Click on the *Windows* menu and select *Settings* or press **Alt-F8** on the keyboard.
- 2 The *Settings* window will open. Click on the tab at the bottom of this window titled *Prefs*.
- 3 At the top of the screen is a checkbox labeled *Load Last Project on startup*. Check this box.



## Front Panel Operation

- 1 On the front panel of the X-48MKII, press the **PREF** button, press the **▲/▼** arrows to select **Load Last Project** and press **CHNG**.
- 2 Use the **▲/▼** buttons to select **0** and press **ENTER**.

---

## Transport Operations

---

### Local

The X-48MKII has six transport buttons you should already be familiar with. These buttons are found on the front panel and on the VGA display:

- |              |   |
|--------------|---|
| <b>REW</b>   | Rewinds the transport. After rewinding for three seconds, it rewinds at a faster rate. After another three seconds, faster still. |
| <b>F FWD</b> | Puts the transport in Fast-Forward. It moves at increasingly faster rates like the Rewind button.                                 |
| <b>STOP</b>  | Stops playback, recording or loop playback.   |
| <b>PLAY</b>  | Starts playback, loop playback or loop recording.   |

**RHSL** Starts Rehearsal recording. This simulates recording (changing input monitor modes as selected) without actually punching into record. It can also be used to set punch in/out points.

**REC** Starts recording when pressed at the same time as **PLAY**. It can start recording on its own if **0 e B tto Reco d** is set to on, (see next section).

---

## One-Button Record

This function allows recording to begin when the **record** button is pressed by itself, instead of requiring both the **record** and **play** buttons to be pressed at the same time.



## Mouse/Keyboard Operation

- 1 Click on the *Windows* menu and select *Settings* or press **Alt-F8** on the keyboard.
- 2 The *Settings* window will open. Click on the tab at the bottom of this window titled *Transport*.
- 3 At the top of the screen is a checkbox labeled *One Button Record*. Check this box.



## Front Panel Operation

- 1 On the front panel of the X-48MKII, press the **PREF** button, press the **▲/▼** arrows to select **0 e B tto Reco d** and press **CHANGE**.
- 2 Use the **▲/▼** buttons to select **0** and press **Enter**.

---

## TC Chase

The TC Chase feature allows your X-48MKII to chase incoming timecode.



## Mouse/Keyboard Operation

Click *TC Chase* at the top center of the connected display.



## Front Panel Operation

- On the front panel of the X-48MKII, press the **TC CHASE** button. The unit will chase time code according to the setting made in the *Settings* menu *Time Code* item.

### NOTE

To set the timecode, click the *Windows* menu and select the *Settings* item (or press **Alt-F8** on the keyboard) to open the *SETTINGS* screen. Click the *Sync* tab and select the timecode next to the *Timecode* item.

## 5 – Recorder

### Rehearse

The Rehearse feature allows you to hear the effects of recording without actually recording to disk. This feature is useful for testing auto-punch in and out points or for rehearsing talent before recording.



Mouse/Keyboard Operation

- Click on the **REH** button in the transport section in the top-right corner of the screen.



Front Panel Operation

- Press the **RHSL** button.

This function, however, works only when “One-button rehearsal” has been set, as described below.

#### ■ One-button rehearsal



Mouse/Keyboard Operation

- 1 Click the *Windows* menu and select the *Settings* item (or press **Alt-F8** on the keyboard) to open the **SETTINGS** screen. Click the *Transport* tab.
- 2 Put a check into the *One Button Rehearse* checkbox at the top of the screen.



Front Panel Operation

- 1 Press the **PREF** button.
- 2 Use the **▲/▼** buttons to select **One Button Rehearse** and push the **CHNG** button.
- 3 Use the **▲/▼** buttons to select **ENTER** and push the **ENTER/YES** button.

### Pre/Post Roll

You can set the pre-roll and post-roll times for starting and ending points when looping. For details about looping, see “Loop Playback” on page 32.



Mouse/Keyboard Operation

- 1 Click on the *Windows* menu and select *Settings* or press **Alt-F8** on the keyboard.
- 2 The *Settings* window will open. Click on the tab at the bottom of this window titled *Transport*.
- 3 Click the checkbox labeled *Enable Pre/Post-Roll*. You can click on the fields for *pre-roll* and *post-roll* to specify how many seconds you require.



Front Panel Operation

- 1 On the front panel of the X-48MKII, press the **PREF** button. Use the **▲/▼** buttons to select **Use Pre/Post-Roll** and press **CHNG**.
- 2 Use the **▲/▼** buttons to select **0** and press **Enter**.
- 3 Pre-roll and Post-roll times can also be changed in the *Preferences* menu.

### Varispeed

Varispeed playback changes the playback speed of the recorder, re-sampling at the output to maintain the selected sample rate. It can be useful when an instrument cannot be tuned to match a recording or to speed up or slow down a song's playback (while simultaneously changing the pitch).



Mouse/Keyboard Operation

- 1 Click on the *Windows* menu and select *Settings* or press **Alt-F8** on the keyboard.
- 2 Click the *Sync* tab.
- 3 Click on the checkbox labeled *Varispeed*. Use the slider or click in the text box to specify the amount of varispeed.

### Recording as a timecode slave

In order to assure recording when functioning as a timecode slave, if unlocked recording operations are disabled and recording cannot be conducted. This is the same as with TASCAM DTRS series and MX-2424 units. To start recording when functioning as a timecode slave, the unit must be locked (PLAY LED lit).

### Recording and Playing Back

#### Input Monitoring

There are four options for input monitoring:

##### Normal input monitoring

Normal input monitoring puts any track that's in record in input monitoring. Whether the transport is in play, record or stop, you will hear the input only and not what is recorded. This mode is typically used for tracking.

##### Auto Input mode

When the recorder is in Auto Input mode, you will hear the input when the transport is in stop or record. When the transport is in play, you will hear what was previously recorded. This mode is used for punch-in recording, so that the artist and engineer can hear what was previously

on the track before recording over a section of that performance.

### ADR Monitoring Mode

ADR Monitoring Mode is similar to Auto Input, but puts the track in input only when the transport is in record. The track reverts to playback in stop or play to prevent feedback.

### All Input mode

All Input mode enables input monitoring for all tracks, whether they are armed for recording or not. This mode is often used for live recording.

Input monitoring can be set the following ways.



#### Mouse/Keyboard Operation

- For Auto Input, click on the *Options* menu, scroll over the *Auto Input* submenu and select *On* or *ADR*.
- For All Input, click on the *Options* menu and select *All Input*.



#### Front Panel Operation

- To enable Auto Input, press the **AUTO INPUT** button on the front panel.
- For All Input mode, hold the **SHIFT** button while pressing **AUTO INPUT**.

### Putting Individual Tracks into Input

#### TIP

When auto input is off, you can set the input mode for individual tracks.

You can put tracks into input mode on a channel-by-channel basis.

- 1 From the **Mouse/Keyboard** interface, click the **I** button next to any track number.
- 2 From the front panel, hold the **SHIFT** button and press any track arming button.

## Record Enable



#### Mouse/Keyboard Operation

- Click on the **R** button to the right of the track numbers on the left side of the screen in the *Tracks* view. The button will flash red to indicate it is ready for record.



#### Front Panel Operation

- Press the **Record Enable** buttons on the front panel. The **Record indicator** will flash on tracks that are ready to record.

## Punch Crossfade Time

To avoid an audio click when punching in and out of record, the X-48MKII automatically fades into and out of record. This crossfade time is very fast, but prevents an audio pop. The crossfade time can be set between 0ms (disabled) and 90ms in increments of 10ms.



#### Mouse/Keyboard Operation

- Click on the *Windows* menu and select *Settings*. Select the *Prefs* tab and click the *Punch Crossfades* submenu. Select the desired crossfade time.



#### Front Panel Operation

- Press the **PREF** button and use the **▲/▼** buttons to select **Punch Crossfade**. Press the **CHNG** button, select the desired crossfade time using the **▲/▼** buttons and press **CHNG** again.

## Undo/Redo

Unlike tape machines, you can undo a recording pass and then put it back with redo. Undo/redo is only available from the mouse/keyboard interface.



#### Mouse/Keyboard Operation (only)

- Click the *Edit* menu and choose *Undo* or press **Control-Z** on the keyboard.
- To redo an operation, click the *Edit* menu and select *Redo* (or press **Control-Y** on the keyboard). You can also use the *History List* to undo and redo. For details, see “*History List*” on page 44.

## Metering

You can change various settings for the GUI meters shown at the top of the screen on a connected display.

#### TIP

If the GUI meters are not shown, click the meter button or press the keyboard “1” key to show them. (The numeric keypad “1” does not have this function.)

Meter button



# 5 – Recorder

## Peak Hold

Turn Peak Hold on or off.

## Pre-fader/Post-fader

Select whether the meters show the signals before (pre) or after (post) the faders. (This option is disabled when in mixer bypass mode.)

## View Masters

Set the track level meter display area to show the GROUP and AUX Master level meters.

## Clear Overloads

Select to clear overload indicators.



### Mouse/Keyboard Operation

- 1 Click the *Options* menu and select the *Meters* item. From this item, you can select *Mode*, *Peak Hold*, *View Masters* and *Clear Overloads*.
- 2 Select the *Mode* item and click *Pre-Fader* or *Post-Fader* to select whether the meters show the signals before or after the faders.
- 3 Click the *Peak Hold* item, putting a check next to it, to turn it on.
- 4 Click *View Master*, putting a check next to it, to switch from showing level meters for the 48 tracks to showing them for GROUP and AUX masters.

### NOTE

You can also directly click the meters on the screen to show the levels of the GROUP, AUX and stereo masters.

- 5 Click *Clear Overloads* to clear overload indicators.

### NOTE

To set the length of time that overloads are shown, click the *Windows* menu and select the *Settings* item. Click the *Prefs* tab and from the *Clear Overloads* pulldown, select *1 second*, *5 seconds*, *30 seconds* or *Hold* (∞).



### Front Panel Operation

- 1 Press the **PREF** button, and use the **▲/▼** buttons to select *Meters* and press the **CHNG** button.
  - 2 Set the *Peak Hold*, *Meter Mode* and *Meter View Range* items.
- **Peak Hold setting**  
Use the **▲/▼** buttons to select *Peak Hold*.  
Use the **▲/▼** buttons to select **0** (default) or **Off** and press the **ENTER/YES** button to change the setting.

- **Pre-Fader/Post-Fader selection**  
Use the **▲/▼** buttons to select *Meter Mode* and press the **CHNG** button.  
Use the **▲/▼** buttons to select *Pre-Fader* or *Post-Fader* and press the **ENTER/YES** button to change the setting.
- **Changing the scale (Meter View Range)**  
Use the **▲/▼** buttons to select *Meter View Range* and press the **CHNG** button.  
Use the **▲/▼** buttons to select **-∞ to 0dB** (default), **-24dB to 0dB** or **-12dB to 0dB** and press the **ENTER/YES** button to change the setting.

### TIP

A finer dB scale is useful, for example, when sending a test tone to a recorder for adjustment of an analog I/O card or a Dolby encoder.

## Using Markers

Markers allow you to label sections of a recording for visual reference and to locate back to later.



### Mouse/Keyboard Operation

- To create a marker, click the *Edit* menu and select *New Marker* or press the **Enter** key on your keyboard's number pad.
- To access a memory location, open the *Markers* window from the *Windows* menu. From here you can select a memory location, rename it and locate to it.

## Loop Playback

You can loop a section of the timeline for playback or recording. The loop plays back (with preroll and postroll settings, if assigned) until the stop button is pressed.

Depending on the loop playback mode settings, the number of times playback loops, for example, will differ.

Loop button



### Mouse/Keyboard Operation

- 1 Click the loop button to enable loop playback (button lights).  
The beginning and stop points of the loop are shown with blue triangles on the timeline ruler. By default, both the start and stop points are set at *00:00:00:00*.
- 2 Drag the loop start and stop points to the location you want them.  
In addition, you can also capture the current time as the loop start or stop point by opening the *I/O*



*Marker Properties* screen (select from *Windows* menu) and selecting *Loop*. You can also enter them directly on this screen.

You can also capture loop points during loop playback. Use the keyboard F key to set the start point and the T key to set the stop point.

#### NOTE

The loop interval is not shown on the screen when the loop function is off.

- 3 Press *Play*.
- 4 To disable the loop function, click the loop button again.

## Loop Mode

The X-48MKII has three Loop Modes:

### Play Once and Cue

*Play Once and Cue* plays through the loop once, then locates to the beginning of the loop (or pre-roll point if enabled) and stops.

### Play Once and Stop

*Play Once and Stop* plays through the loop once and then stops at the loop end (or post-roll point if enabled).

### Play Repeatedly

*Play Repeatedly* plays through the loop, locates to the beginning of the loop (or preroll point if enabled) and plays again, repeating until the stop button is pressed.

By default, the Loop mode is set to *Play Once and Cue*. To change this behavior:



Mouse/Keyboard Operation

- 1 Click on the *Windows* menu and choose *Settings*.
- 2 Select the *Transport* tab.
- 3 The submenu titled *Loop Mode* has the three choices explained above. You can also set the playback mode using the *LOOP MODE* item on the *I/O MARKER Properties* screen (select from the *Windows* menu).



Front Panel Operation

- 1 Press the **PREF** button. Press the **▲/▼** buttons until you select **LOOP Mode** and press **CHNG**.
- 2 Select one of the three choices explained above and press **Enter**.

## Auto Punch

The Auto Punch function automatically drops into and out of record when switched on. This is used to automate a difficult punch in and out, such as one word in a lead vocal or an ADR (automated dialog replacement) line that will be attempted several times.



Mouse/Keyboard Operation

- 1 First, set the punch in and punch out points. At the default setting, the starting and ending points of the last recording are automatically set as the in and out points, respectively. You can disable this automatic setting by opening the *Transport* tab of the *SETTINGS* screen (select the *Settings* item from the *Windows* menu), and remove the check mark next to the *Update Punch Points* item.)

You can also drag the punch in and out points in the timeline ruler, they are the red triangles that fill the timeline ruler. You may want to zoom into a waveform and set the markers manually if you're trying to replace or spot-erase some recorded audio.

In addition, you can also capture the current time as the punch in or punch out point by opening the *I/O Marker Properties* screen (select from *Windows* menu) and selecting *Punch*. You can also enter them directly on this screen.

- 2 Hold the *Shift* button and click the *Record* button on the onscreen transport to switch on *Auto Punch* mode. The *Record* light will flash.
- 3 Move the transport to a location before the punch-in point and press *Play*. When the transport reaches the punch-in point it will punch into record. When it passes the punch-out point it will go into play again.



Front Panel Operation

- 1 First, set the punch in and out points. By default, the recorder remembers the last timecode that you punched into and out of record and uses these for your punch in and out points. (To change this behavior, press the **PREF** button to open the Preferences menu and use the **▲** and **▼** buttons to select **Update P ch Poi ts** and change that setting to **Off**.) You can use the **Rehearse** button to punch in and out of record without actually recording to set new punch in and out points.
- 2 To enter **A to P ch** mode, hold the **SHIFT** button and press **RECORD**. The **Record** light will flash.
- 3 Move the transport to a location before the punch-in point and press **PLAY**. When the transport reaches the punch-in point it will punch into

## 5 – Recorder

**record. When it passes the punch-out point it will go into play again.**

### NOTE

Press the **SHIFT** and **REC** buttons again to disable Auto Punch mode.

### Loop Recording

You can also record while in loop mode. When you record in loop mode (and non-destructive recording is selected), a new audio file is written each time the recorder makes a pass. You might use this feature when trying multiple successive takes of a guitar solo, for example. To use the loop recording feature, turn on both *Loop Playback* and *Auto Punch* and press **Play**. (See previous sections.)

### Audio pool

Select the *Windows* menu *Audio Pool...* item on the connected display, or press **Ctrl-P** on the keyboard to open the audio pool screen.

The audio pool screen shows all the audio files referenced by the currently open project and allows the following operations.

#### Relink

If an audio file that is referenced by an audio clip cannot be found, click the name of that audio clip and click the “*Relink*” button. The currently missing audio file will be searched for and relinked automatically. A referenced audio file can be lost when it has been moved manually using the File Manager, for example, or the external drive that it is on is disconnected.

#### Rename

You can change the file name of an audio file. Doing this will not break links between audio files and audio clips.

#### Remove

You can remove references to audio files. Use this function on audio files that are no longer necessary, for example.

#### Remove Unused

This removes audio regions that are not used in the project from the audio pool. If you put a check next to the *Delete unreferenced audio files* item before clicking *OK*, those audio files will also be erased from the hard disk.

## Using the VGA Recorder Interface

### Meters

The X-48MKII displays meters on the top of the screen by default. To show or hide these meters, click the meter button in the middle of the display. For more about the on-screen meters, see page 31, *Metering*.

Meter button



### Naming Tracks

Each of the tracks can be named for easy reference and for auto-naming recorded wave files.

To name a track:



Mouse/Keyboard Operation (only)

- 1 **Click on the *Tracks* tab at the bottom of the screen or press **F1**.**
- 2 **Double click on the track-name on the left side of the screen, such as *Track 1*.**
- 3 **Type a new name and press **Enter**.**

### Scrolling

You can control the way that tracks scroll on the X-48MKII.

#### None

*None* means that playback will not change the view selected in the screen

#### Auto-Scroll

*Auto-Scroll* means that the center line will remain stationary and the waveform will move under that. The playback line needs to move to the center of the display first, but once it “catches up” it will remain there.

#### Page Flip

*Page Flip* tells the playback line to scroll across the screen, then advance to the next chunk of timeline and scroll across that. This is the same as the default view for Pro Tools.

To change the scrolling behavior:

- 1 **Click the *Options* menu and select *Scrolling*.**
- 2 **Choose either *None*, *Auto-Scroll* or *Page-flip*.**

You can also click the Auto Scroll button in the top left corner of the Tracks display:

Auto Scroll button



## Timebar Format

The time ruler can be displayed in SMPTE time or in samples.

To change this behavior:

- 1 **Click the *Options* menu and select *Timebar Format*.**
- 2 **Choose either *SMPTE* or *Samples*.**

**You can also show a large display of the timecode position in a separate window. Click *Time Display* in the *Windows* menu to open the timecode position display in a separate window.**

## Clip Properties

To specify information about a clip, open the *Clip Properties* window:

- 1 **Use the *Smart* tool to select a clip.**
- 2 **Under the *Windows* menu, select *Clip Properties...* or press **Control-2** from the keyboard.**
  - **You can check file name changes, start point and end point settings, audio clip movements (timecode contained in broadcast wave files or changes in playback position), track numbers and other metadata (Coding History).**
  - **You can also specify a fade in and fade out time and shape from this window, mute or lock the clip position.**

Another way to edit these values, without opening the *Clip Properties* window, is to click the *Info* button in the display. A new panel opens up below the transport with the same clip options.



## Navigating the Timeline

There are several ways to change the playhead position:

- **Drag the bottom scrollbar left and right, then click in the track display to jump to that position.**
- **Use the *Fast Forward* and *Rewind* buttons, either on-screen or on the front panel.**
- **Double-click the timecode position readout and type in a new location with the keyboard.**
- **Use an external machine control device (see next section on *Synchronization*).**

## Status Displays

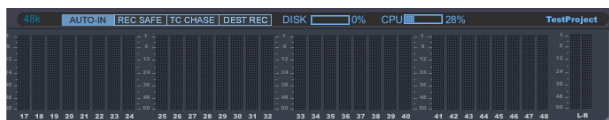

To the right of the menu displays, you should see a screen similar to the one above. This shows, from left to right:

- Current sample rate
- Auto input (AUTO IN), all recordings safe (REC SAFE), Timecode Chase (TC CHASE) and destructive recording (DEST REC) status (indicators appear blue when enabled)
- Hard disk usage and remaining recording time
- CPU load
- Project name

## Changing part colors on the track screen

Click *Color Setup* in the *Option* menu to open the *Color SETUP* screen where you can change the color of clip backgrounds, clip waveforms and other items, allowing you to customize their appearance.

These color changes are saved with the project.

## Synchronization

### Requirements

In order to reliably synchronize the X-48MKII to another device, two references are required:

#### Location reference

Usually, this is SMPTE (LTC) timecode input through the unit's **TIME CODE IN** connector or MTC timecode input through the **MIDI IN** connector. This tells the X-48MKII where in the timeline to go.

#### Clock reference

A clock reference, typically word clock sent to the X-48MKII through a BNC cable. This tells the X-48MKII how fast to go once it gets to the right location.

The X-48MKII can run without an external word clock source, but it will eventually drift out of sync. (You can also use a digital audio signal such as AES/EBU as a clock source.) You will also hear clicks and pops in the digital audio if your entire studio is not resolved to a single master clock.

Note that video clock is available on the X-48MKII, but it cannot be used as the reference clock. Video clock is only updated 60 times per second, where word clock is updated 48,000 times or more per second. Long cable runs can also cause video clock to go out of phase, which may cause problems with digital consoles. Video clock on the X-48MKII is used to define the frame edge of the SMPTE input.

#### Word Clock

Word Clock sets the playback speed. Once the transport position has been determined by the SMPTE input, the unit follows the clock rate of the sample clock source when playing back. (Set the clock source with the *Source* item on the *Sync* tab of the *SETTINGS* screen (select the *Settings* item from the *Windows* menu).)

## 5 – Recorder

### Video Clock

Video Clock gives a precise frame edge to the SMPTE timecode. Not available as a clock reference.

### SMPTE Timecode

SMPTE Timecode is used as a location reference, defining where in the timeline to locate to.

### MIDI Timecode

MIDI Timecode (MTC) is sometimes used as a location reference with MIDI sequencing software or computer-based DAW software

### RS-422

In addition to receiving playback, record and other transport commands, track record arming can also be controlled

As these reference sources are all related, you can see the importance of making sure that all of your devices are resolved to the same clock reference. Another way to look at sync on the X-48MKII is to examine the order that things happen when the X-48MKII is online:

1. The X-48MKII either sees a transport command from the RS-422 signal or sees SMPTE timecode and goes into play.
2. The X-48MKII looks at either the SMPTE input or the RS-422 to determine where in the timeline to begin playback.
3. If enabled, the X-48MKII looks to the video clock input for a more exact timestamp for the incoming SMPTE.
4. Once the X-48MKII is locked to the right SMPTE frame, it starts playing at the rate dictated by its sample clock source.
5. If the input SMPTE drops out or is otherwise interrupted, playback (or recording) will stop while the timecode is interrupted depending on the Chase Freewheel setting. Moreover, if the input timecode and the unit's timecode drifts beyond the Relock Threshold value, the input timecode will either be rechased or the drift will be ignored and playback will continue depending on the Chase Relock setting.
6. When SMPTE timecode stops or an RS-422 stop command is received, the transport stops.

## Sample Rate

A sample rate should be chosen when first creating a project, with consideration to what will be done with the final product. Your choices are:

- 44100 (CD standard)
- 48000 (DVD standard)
- 88200 (2x CD standard)
- 96000 (2x DVD standard)
- 42336 (44.1k conversion from film (24) to PAL (25))
- 44056 (44.1k pull-down)
- 44144 (44.1k pull-up)
- 45938 (44.1k conversion from PAL (25) to film (24))

- 46080 (48k conversion from film (24) to PAL (25))
- 47952 (48k pull-down)
- 48048 (48k pull-up)
- 50000 (48k conversion from PAL (25) to film (24))
- 84672 (2x 44.1k conversion from film (24) to PAL (25))
- 88112 (2x 44.1k pull-down)
- 88288 (2x 44.1k pull-up)
- 91875 (2x 44.1k conversion from PAL (25) to film (24))
- 92160 (2x 48k conversion from film (24) to PAL (25))
- 95904 (2x 48k pull-down)
- 96096 (2x 48k pull-up)
- 100000 (2x 48k conversion from PAL (25) to film (24))

If you change the sample rate after audio has been recorded, that audio will play back at a different pitch. To change the sample rate:



### Mouse/Keyboard Operation

- 1 **Click the *Windows* menu and select the *Settings* window.**
- 2 **Click the *Sync* tab and set the sampling frequency using the *Rate* item in the *Sample Clock* section.**



### Front Panel Operation

- 1 **Press the SYNC button. Press the ▲/▼ buttons to select *Sample Rate* and press CHNG.**
- 2 **Select a sample rate from the list using the ▲/▼ buttons and press Enter.**
- 3 **When *Change Sample Rate OK?* appears, press the ENTER/YES button.**

## Clock Source

One of the most important settings on the X-48MKII is the sample clock source, which governs playback speed and keeps audio pops from happening. There are five choices.

### Internal

Internal is the default. This can be used if the X-48MKII is either used by itself, with an analog console or as the master clock for the studio.

### Word Clock

Word Clock should be used when you have an external, dedicated master clock available. The word clock generator needs to be set to the same sample rate as the X-48MKII.

### S/PDIF

S/PDIF clocks the X-48MKII from the digital audio signal coming into the S/PDIF Digital Input.

### TDIF Port 1

TDIF Port 1 clocks the X-48MKII from the digital audio signal coming into the TDIF Digital Input channels 1-8.

If you have digital audio option cards installed (IF-AD24(X) / IF-AE24(X)), those will show up as an available clock source as 'ADAT Card' / 'AES/EBU Card'.

When in doubt, use *Word Clock* as the reference source. To change the clock source:



Mouse/Keyboard Operation

- **Click the *Windows* menu and select the *Settings* window.**
- **Click the *Sync* tab and click the *Source* item in the *Sample Clock* section.**

**Choose your desired master clock from the list.**



Front Panel Operation

- 1 Press the SYNC button. Press the ▲/▼ buttons to select *Sample Clock Source* and press CHNG.**
- 2 Select a clock source from the list using the ▲/▼ buttons and press Enter.**

### BNC Clock In/BNC Clock Out

These parameters allow the word clock signal input or output to be multiplied or divided by 2, or used as-is. This allows, for example, a 48 kHz word clock generator to be used when recording at 96 kHz, or allows 48k and 96k devices to be used at the same time.

To change these settings:



Mouse/Keyboard Operation

- 1 Click the *Windows* menu and select the *Settings* window.**
- 2 Click the *Sync* tab and click the *BNC In* or *BNC Out* item in the *Sample Clock* section. Choose a setting from the list.**



Front Panel Operation

- 1 Press the SYNC button. Press the ▲/▼ buttons to select *BNC Clock In* or *BNC Clock Out* and press CHNG.**
- 2 Use the ▲/▼ buttons to select a setting and press Enter.**

### BNC Word Clock Output Polarity

This setting allows the Word Clock signal outphase to be reversed. This may be necessary in large systems or with long cable runs.



Mouse/Keyboard Operation

- 1 Click the *Windows* menu and select the *Settings* window.**
- 2 Click on the *Sync* tab and check the box labeled *Invert Word Out Polarity*.**



Front Panel Operation

- 1 Press the SYNC button. Press the ▲/▼ buttons to select *Word Out Polarity* and press CHNG.**
- 2 Use the ▲/▼ buttons to select either *Normal* or *Inverted* and press Enter.**

### Video Clock Frame-Edge Resolve

Video Clock in the X-48MKII can be used to define the frame edge of incoming and generated timecode for stability and repeatability. (But not as a sample clock source, see "Requirements" on page 35.)

To enable video clock:



Mouse/Keyboard Operation

- 1 Click the *Windows* menu, select the *Settings* window and click the *Sync* tab.**
- 2 Check the box labeled *Resolve to Video In* in the *Time Code* area.**



Front Panel Operation

- 1 Press the SYNC button. Press the ▲/▼ buttons to select *Resolve to Video In* and press CHNG.**
- 2 Press the ▲/▼ buttons to select *0* and press Enter.**

### Frame Rate

The X-48MKII syncs to any frame rate of SMPTE timecode:

- **30-frame non-drop (30 NDF)** is occasionally used in music studios to sync console automation to a tape machine (2" reel-to-reel tape may be striped with this format)
- **30-frame drop (30 Drop)** is rarely used
- **29.97 non-drop (29.97 NDF)** is the standard for non-broadcast post-production in the U.S.

## 5 – Recorder

- **29.97 drop (29.97 Drop)** is the standard for broadcast television post production in the U.S.
- **25-frame non-drop (25 NDF)** is the standard in Europe
- **24-frame non-drop (24 NDF)** is sometimes used for HDTV production or film location recording
- **24.975 non-drop (24.975 NDF)** is 25-frame pull-down, used to play 25-frame videos on American NTSC monitors
- **23.976 non-drop (23.976 NDF)** is “HD pull-down,” used to play down-converted HD videos on American NTSC monitors

To change the frame rate:



### Mouse/Keyboard Operation

- 1 **Click the *Windows* menu and select the *Settings* window.**
- 2 **Click on the *Sync* tab and click the *Frame Rate* submenu. Choose your desired frame rate from the list.**



### Front Panel Operation

- **Press the SYNC button. Press the ▲/▼ buttons to select *F a e Rate* and press CHNG.**
- **Select a frame rate from the list using the ▲/▼ buttons and press Enter.**

## Control Mode

Four control modes are available:

### Internal

Internal is the default setting, the X-48MKII controls its own transport and ignores the SMPTE timecode input.

### SMPTE

SMPTE follows the SMPTE timecode input for location, from the TIME CODE input on the rear panel.

### MIDI (MTC)

MIDI (MTC) looks to the MIDI input for timecode.

### Theater Play

Theater Play plays a section of the timeline, stops, and waits for a Play command to play the next section.

### ■ Theater Play mode overview

Using the Theater Play mode, you can play back cues one after another. This function is useful for triggering the playback of musical cues and effects during theater and radio performances, for example.

To activate this mode, use a mouse and keyboard or the front panel of the unit to set the control mode to Theater Play.

In this mode, you can playback and locate to cues.

Each cue contains two items of time data: the start point and the stop point.

Cue number 1 starts at the time set for marker #0 and stops at the time set for marker #1. Cue number 2 starts at marker #2 and stops at marker #3. Cue number 3 uses markers #4 and #5, and so on.

Before enabling Theater Play mode, a cue must be set within the project.

The total number of markers in a project must be even (e.g. #00–#07). If the total number of markers in a project is odd, the transport will not locate to the final marker.

In this mode, press the PLAY button to start playback from the beginning of the first cue (marker #0). Playback will continue until the end of the cue (marker #1) and then the transport will locate to the beginning of the next cue (marker #2) and stop. When the unit is instructed to play again, it will play this cue.

If you connect a footswitch to the **FOOT SWITCH** jack on the rear panel of the unit, you can trigger playback by pressing the footswitch. In other words, the footswitch functions as the PLAY button in theater mode.

### ■ Theater Play mode operation

- When the control mode is set to Theater Play, pressing the FF or REW button will locate to the playback start marker of the previous or next cue and standby.
- During playback of a cue, press the STOP button to stop playback at that point. Press the PLAY button again to locate to the starting marker of that cue and start playback again.
- Recording is not possible when the control mode is set to Theater Play.
- The second line of the front panel display shows the current cue number and the marker numbers assigned to that cue when the control mode is set to Theater Play.
- During Theater Play, you can press the *REH* button to enable rehearsal mode, allowing playback from the middle of a cue.

Click the *Markers* item in the *Windows* menu to open the *MARKERS* screen. On the *MARKERS* screen, you can locate to the cue you want, and play it back. In addition, you can click the *Theatre Playlist* in the *Windows* menu to open the *THEATER PLAYLIST* screen. On the *THEATER PLAYLIST* screen, you can reorder cues as you like.

Put a check next to *Enable Theatre Playlist* to play back cues in the *THEATER PLAYLIST* order.

To change the control mode:



### Mouse/Keyboard Operation

- 1 **Click the *Windows* menu and select the *Settings* window.**

- 2 Click on the *Sync* tab and click the *Control Mode* submenu. Choose the desired control mode from the list.



Front Panel Operation

- 1 Press the SYNC button. Press the ▲/▼ buttons to select *Control Mode* and press CHNG.
- 2 Select a control mode from the list using the ▲/▼ buttons and press Enter.

## Chase Freewheel

Use the *Chase Freewheel* item to set how much drift caused by input timecode dropouts and other gaps will be tolerated before the unit stops chasing timecode. Playback stops when drift exceeds this value.

When input timecode is next recognized, chase is restarted (when in recording mode, it stays unlocked).

Use the following procedures to set freewheel to 0, 5, 10, 20, 50, 100 frames or ∞ (Infinite).

When set to ∞ (Infinite), the unit will continue playback/recording regardless of input timecode.

To change the setting:



Mouse/Keyboard Operation

- 1 Click the *Windows* menu and select the *Settings* window.
- 2 Click on the *Sync* tab and click the *Chase Freewheel* submenu. Choose the desired setting from the list.



Front Panel Operation

- 1 Press the SYNC button. Press the ▲/▼ buttons to select *Chase Freewheel* and press CHNG.
- 2 Select a value from the list using the ▲/▼ buttons and press Enter.

## Chase Relock

If the SMPTE drifts outside of the *Chase Relock Threshold* window (see next section), this setting tells the X-48MKII what to do.

### Always

Always tells the transport to shift to the correct timecode value, even if it's in record.

If the threshold value is exceeded and re-chase occurs, recording mode will be disabled.

### Only if not recording

Only if not recording shifts the transport in play but not in record.

During recording, timecode drift is ignored and recording continues.

### Never

During both recording and playback, timecode drift is ignored.

To change the re-lock setting:



Mouse/Keyboard Operation

- 1 Click the *Windows* menu and select the *Settings* window.
- 2 Click on the *Sync* tab and click the *Chase Relock* submenu. Choose a setting from the list.



Front Panel Operation

- 1 Press the SYNC button. Press the ▲/▼ buttons to select *Chase Relock* and press CHNG.
- 2 Choose a setting from the list using the ▲/▼ buttons and press Enter.

## Chase Relock Threshold

This parameter governs how far out of sync the X-48MKII can drift before the Chase Relock feature forces it back in sync. (Or not, see previous section.) The range is *AUTO*, *1/3 frame*, *1 frame*, *2 frames*, *5 frames* or *10 frames*.

During recording, if the chase relock threshold setting is exceeded and re-chase occurs, recording mode will be disabled.

This setting can only be changed from the GUI interface.



Mouse/Keyboard Operation (only)

- 1 Click the *Windows* menu and select the *Settings* window.
- 2 Click on the *Sync* tab and click the *Relock Threshold* submenu. Choose a setting from the list.

## 5 – Recorder

---

### Timecode Offset

This offsets the transport from the incoming timecode. The offset can be either positive or negative.

To change the offset:



Mouse/Keyboard Operation

- 1 Click the *Windows* menu and select the *Settings* window.
- 2 Click on the *Sync* tab and click in the *Time Code Offset* field. Type a new offset with the keyboard.



Front Panel Operation

- 1 Press the **SYNC** button. Press the **▲/▼** buttons to select *Chase Offset* and press **CHNG**.
- 2 Use the **CHNG** and **HOME** buttons to cursor through the display. Use the **▲/▼** buttons to change the offset. Press the **Enter** button to save your offset.

---

### Chase Lock Deviation

Chase Lock Deviation displays the difference between incoming timecode and the X-48MKII's transport. It can be useful if you think that the machine is drifting out of sync or for troubleshooting. There is no setting to change, it's only a display of how far out of sync the machine is (ideally 0). To view this setting:



Mouse/Keyboard Operation

- 1 Click the *Windows* menu and select the *Settings* window.
- 2 Select the *Sync* tab. Look at the *Lock Deviation* display at the bottom of the screen.



Front Panel Operation

- 1 Press the **SYNC** button. Press the **▲/▼** buttons to select *Chase Lock Deviation* and press **CHNG**.
- 2 Watch the lock deviation. When you're finished, press the **Exit** or **Home** button.

---

### Timecode Output Muting

This setting is useful when the device receiving timecode cannot accept off-speed timecode, such as some console automation systems.

#### Play Only

Outputs timecode only when the transport is running at a normal play speed.

#### Mute FF/Rew

Mutes the timecode output when in FF or REW.

#### Mute Jog/Shuttle

Mutes the timecode when the transport is running at a non-play speed such as shuttle.

#### None

The timecode is never muted.

To change this setting:



Mouse/Keyboard Operation

- 1 Click the *Windows* menu and select the *Settings* window.
- 2 Select the *Timecode Output Muting* submenu and choose a setting.



Front Panel Operation

- 1 Press the **SYNC** button. Press the **▲/▼** buttons to select *Timecode Muting* and press **CHNG**.
- 2 Select a setting and press **Enter**.

---

## Advanced Recorder Operations

---

### Audio File Naming

The X-48MKII can auto-name new audio files either based on the project name or the track name. This setting can only be changed from the GUI. Since there are no track names visible when using the LCD, it defaults to naming audio files based on the project name.

To change this preference:



Mouse/Keyboard Operation (only)

- 1 Click the *Windows* menu and select the *Settings* item and then the *Prefs* screen.
- 2 Select the *Audio File Naming* submenu and choose your preferred naming convention.



## Track Key Punch

The X-48MKII can be set to enter record mode without any tracks armed. Recording will then begin on any channel whose track-arming button is pressed.

In other words, even when all track record arming buttons are off, you can press the transport **REC** and **PLAY** buttons to start recording mode. Then, recording will start when you press a track record arming button.

To enable this function:



### Mouse/Keyboard Operation

- 1 Click the *Windows* menu and select the *Settings* window.
- 2 Select the *Transport* tab. Check the box labeled *Track Key Punch*.



### Front Panel Operation

- 1 Press the **PREF** button. Press the **▲/▼** buttons to select **Track Key Punch** and press **CHNG**.
- 2 Select either **Off** or **0** using the **▲/▼** buttons and press **Enter**.

## Recording time

| Sampling frequencies | Quantization rates | Built-in HDD data volume 960 GB |               | Per 100 GB of external drive capacity |              |
|----------------------|--------------------|---------------------------------|---------------|---------------------------------------|--------------|
|                      |                    | 48 track                        | 24 track      | 48 track                              | 24 track     |
| 44.1 kHz             | 16 bit             | 60 hr 33 min                    | 121 hr 7 min  | 6 hr 33 min                           | 13 hr 07 min |
|                      | 24 bit             | 40 hr 22 min                    | 80 hr 44 min  | 4 hr 22 min                           | 8 hr 44 min  |
|                      | 32 bit floating    | 30 hr 16 min                    | 60 hr 33 min  | 3 hr 16 min                           | 6 hr 33 min  |
| 48 kHz               | 16 bit             | 55 hr 37 min                    | 111 hr 16 min | 6 hr 01 min                           | 12 hr 03 min |
|                      | 24 bit             | 37 hr 05 min                    | 74 hr 11 min  | 4 hr 01 min                           | 8 hr 02 min  |
|                      | 32 bit floating    | 27 hr 49 min                    | 55 hr 38 min  | 3 hr 00 min                           | 6 hr 01 min  |
| 88.2 kHz             | 16 bit             | 30 hr 16 min                    | 60 hr 33 min  | 3 hr 16 min                           | 6 hr 33 min  |
|                      | 24 bit             | 20 hr 11 min                    | 40 hr 22 min  | 2 hr 11 min                           | 4 hr 22 min  |
|                      | 32 bit floating    | 15 hr 08 min                    | 30 hr 16 min  | 1 hr 38 min                           | 3 hr 16 min  |
| 96 kHz               | 16 bit             | 27 hr 49 min                    | 55 hr 37 min  | 3 hr 00 min                           | 6 hr 01 min  |
|                      | 24 bit             | 18 hr 32 min                    | 37 hr 05 min  | 2 hr 00 min                           | 4 hr 01 min  |
|                      | 32 bit floating    | 13 hr 54 min                    | 27 hr 48 min  | 1 hr 30 min                           | 3 hr 00 min  |

- The above recording times are estimates. Actual times will vary depending on the effective data capacity of a drive, the number of projects and other factors.
- The built-in hard disk data volume capacity is the built-in hard disk less the space taken by the system volume.

# 6 – Editing

## Edit Tools

### I-Beam Tool



The I-beam tool is used to select a portion of a recorded clip or clips. When the I-beam tool is dragged through the middle of a clip, only that section will be edited. For example, if you wanted to erase a cough in the middle of a recorded voiceover, the I-beam would allow you to select just that cough and then hit delete on the keyboard. Double-clicking on a clip with the I-beam tool selects the entire clip.

#### NOTE

Editing is only possible using the keyboard and mouse. You cannot edit tracks from the front panel. So all of the instructions in this chapter refer to the mouse, keyboard and monitor interface. These instructions also assume that you have selected the *Tracks* view at the bottom of the screen or by pressing **F1**.



Mouse/Keyboard Operation (only)

- 1 Click on the *I-Beam* button in the top-left corner of the screen (pictured above) or press **F9** on your keyboard.
- 2 Click and drag a portion or a complete clip in the timeline, or multiple clips across multiple tracks. Any editing functions you perform (i.e. cut, copy, paste, delete) will be applied only to the portion of the clip you selected and highlighted.

### Object Tool



Press **F8** to select the Object tool, or click the button pictured above in the top-left corner of the screen.

This tool does different things depending where the mouse is:

- When it's not hovering over a clip, it looks like a cursor (+) sign. You can click and drag over clips to select multiple objects. (It doesn't select only portions of clips like the I-Beam).
- When you mouse over the bottom left or bottom right corner of a clip, you get a tool that looks like a horizontal line with arrowhead on either side. This tool allows you to change the beginning or ending point of a clip. Drag the end point inward to shorten a clip, or drag it back out to lengthen it (if there is any waveform there).

- Mouse over the top left or top right corner, and the tool changes to a horizontal line under a white arc. This is the fade tool, which allows you to add a fade-in or fade-out to a clip. If clips on multiple tracks are selected, the fade-in or -out is changed on all of those tracks.
- Move to the middle of a clip, and your cursor changes into the finger tool. Click and drag to move the clip (or multiple selected clips).

### Smart Tool



Press **F11** to select the Smart tool, or click the button pictured above in the top-left corner. Like the Object tool, this tool does different things depending where your mouse is:

- When it's not hovering over a clip, or if it is over the bottom half of a clip, it acts like the I-Beam tool. Like the I-Beam tool, you can select a portion of a waveform. However, unlike the I-Beam tool, you can only select audio on a single track.
- When you mouse over the bottom left or bottom right corner of a clip, you get a tool that looks like a horizontal line with arrowhead on either side. This tool allows you to change the beginning or ending point of a clip. Drag the end point inward to shorten a clip, or drag it back out to lengthen it (if there is any waveform there).
- Mouse over the top left or top right corner, and the tool changes to a horizontal line under a white arc. This is the fade tool, which allows you to add a fade-in or fade-out to a clip. If clips on multiple tracks are selected, the fade-in or -out is changed on all of those tracks.
- Move to the top half of a clip, and your cursor changes into the finger tool. Click and drag to move the clip (or multiple selected clips).
- Double-click on a clip with the Finger tool and you get the *Clip Properties* window. See page 35 for more on this window.

### Magnify Tool



Press **F12** to select the Magnify tool, or click the button pictured above in the top-left corner. The magnify tool allows you to select a section of the timeline to fill the screen. To use this tool, click and drag over the section you want to focus on, such as a pair of clips on tracks 1 and 2. When you release the mouse, those two clips will fill the VGA screen.

---

## Selecting & Editing

---

### Selecting Clips

To select complete clips, use the Object tool. To select a portion of a clip or clips, use the I-beam or Smart tool. See the previous section for more information.

### Selecting Time

To select a range of time across all tracks, mouse over the timeline above all of the tracks. No matter which tool you've been using, the cursor will change into an I-beam tool. Click and drag in the time ruler to select a time range across all tracks. Your selection is displayed with in/out point markers, described in the next section.

### In and Out Points

Your selection range is displayed on-screen by the in and out point markers, which look like small blue flags in the timeline ruler.

To see exactly what has been selected, click the info button. The screen will show information about your selection start and end points as well as the length of the selection. For an exact time selection, such as 00:02:00:00, you can click in these fields and type in a new in point, out point or selection length.

In addition, you can open the *I/O Marker Properties* screen (select from the *Windows* menu) and select *Selection* to input in and out points directly.



---

### Clip Properties

There are three ways to call up this window:

- **With a clip selected, click the *Windows* menu and select *Clip Properties*.**
- **With a clip selected, press **Control-2** on the keyboard.**
- **Double-click a clip using the **Finger** tool in the **Smart Tool**.**

This window gives you several options for working with a clip:

- **You can name the clip.**
- **Type in exact start, end and length times.**
- **You can also specify an exact fade-in and fade-out time and crossfade shapes, either linear, exponential or reverse exponential.**
- **Clips can also be muted or locked by clicking these checkboxes. Locking a clip makes it impossible to edit until unlocked.**

- **Another set of buttons in the *Clip Properties* window allow you to move the clip either to the timecode embedded in a Broadcast WAVE file ("*Broadcast Time*") or to the current Play Position.**

Click *OK* or *Cancel* to confirm or ignore the changes.

---

### Snap to Grid

Clips can snap to a grid for exact placement of imported or recorded audio in the timeline. To access this feature, click on the *Options* menu and select *Snapping*. This menu has three settings:

#### Enable Snapping

Turns the snap feature on or off.

#### Draw Snap Grid

Displays vertical grid lines in the timeline for visual reference.

#### Snap To

Snap To is another submenu that selects how fine the snap grid is drawn. The options are *Hours*, *Minutes*, *Seconds*, *Frames* or *Subframes*.

---

### Cut, Copy, Delete, Paste

These commands do the expected edit functions to the selected audio. Keyboard shortcuts are **Control-X** for Cut, **Cntl-C** for Copy, **Cntl-V** for paste and **Delete** for Delete. The only one that requires further explanation is Delete, which does not actually delete the audio off the drive but just removes it from the *Edit Decision List* (EDL). You can always undo the operation or, if you have deleted a range of a clip, pull the new clip's head or tail to fill the deleted space.

---

### Repeat Paste

Repeat Paste (**Control-Alt-V**) pastes the audio in the clipboard multiple times. You might use this feature to create a loop that plays through a song or to fill a section of film dialog with room tone for ADR. When you select the repeat paste command, the system will prompt you to ask how many times it should repeat the audio loop.

---

### Crop

Crop (**Control-U**) cuts the head and tail of a clip outside of the selected range. Select a range inside of a clip using the I-Beam tool, then use the Crop command to shorten its length to include only the selected range.

## 6 – Editing

### Insert Time

This command (**Control-T**) inserts silence into the selected time range and shifts all audio after that selection later. It's the same as splitting the clip at the In point and moving all audio after that point back the same amount of time as the selection length.

### Delete Time

This command deletes the time from the timeline represented by the selected time range and shifts all audio after that selection forward.

### Split

The Split command (**Control-E**) slices a clip wherever the timeline is. If you have selected a range of a clip, it separates that selection into a new clip. This separation would allow one part of a clip to be treated or editing differently from the other part of the clip.

### Play From Selection

This function (shortcut “P” on the keyboard) begins playback from the beginning of the selection range. It ignores the pre-roll setting, if any. You might use it to hear the effects of an edit in context of the program.

### History List

The History List command (**Control-H**) opens a window that shows you every edit you've done in the project, up to a maximum of 200 edits. You can press the *Undo* and *Redo* buttons at the bottom of this window, or click on a command in the list and it will undo that edit and everything after it.

History is saved with a project, so undoing is possible even after closing and reloading a project.

You can also *Clear* the history list. Check *Delete unreferenced audio file* and press *OK* to delete all editing data, including unused, unnecessary audio files, from the undo history. After doing this, previous operations cannot be undone.

### Moving clip borders and adjusting crossfades

As shown below, the following example of editing involves three clips—Clip 1, Clip 2 and Clip 3.

- 1 **Clip 2 is a recorded WAVE file that has been edited to remove unnecessary beginnings and endings and then copied and pasted into place. In this case, the beginning and end of Clip 2 can be extended, altering the borders with Clip 1 and 2.**

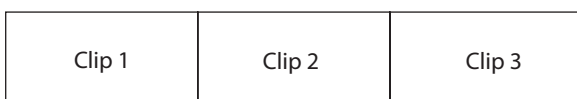

- 2 **Select the object tool.**

When you move the cursor near the border of Clip 1 and Clip 2, it becomes the fade tool, which can be used to adjust the fade-in or fade-out at the top of the clips. At the bottom of the clips, it becomes a double-headed arrow cursor, which can be used to adjust the border between Clip 1 and Clip 2.



- 3 **First, move the double-headed arrow cursor a little to the right of the border and click to make Clip 2 active, and then move the border to the left.**

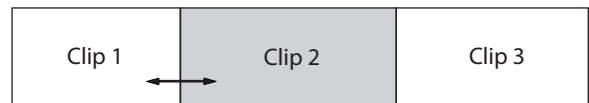

- 4 **You can also edit the crossfade once the clips overlap. Move the double-headed arrow cursor a little to the right of the border and click to make Clip 1 active.**



- 5 **Drag right to adjust the crossfade.**

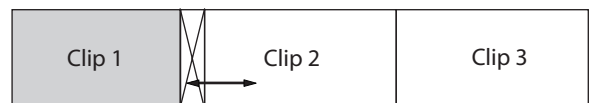

- 6 **You can also drag left to adjust the endpoint of Clip 1. This will not adjust the crossfade.**



- 7 **In step 4 above, move the double-headed arrow cursor a little to the left of the border and click to make Clip 2 active.**

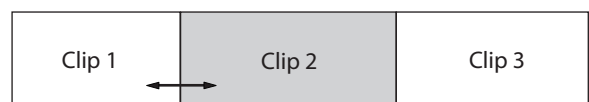

- 8 **Drag left to adjust the crossfade.**

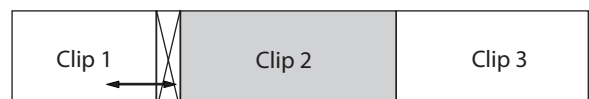

- 9 **You can also drag right to adjust the start point of Clip 2. This will not adjust the crossfade.**

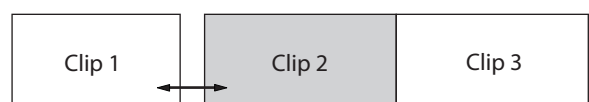

**10** When adjusting the crossfade is possible, the fades of Clip 1 and Clip 2 will not be adjusted, so the fade tool will not appear even when the cursor is placed at the top of a clip.

In addition, if you adjust the start point of Clip 2 or the end point of Clip 1 in step 6 or 9, the clips will no longer overlap, making it impossible to adjust the crossfade. If you have done this, undo the edit so that you can adjust the crossfade.

**11** To readjust the clip border, fix the start point of the clip on the right and the end point of the clip on the left first. For example, adjust the border position so that it is the same as in step 3.

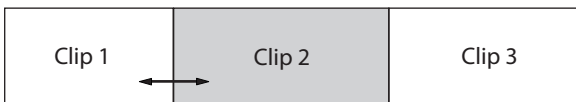

**12** To move the clip border further to the left, move the double-headed arrow cursor little to the left of the border and click to make Clip 2 active.

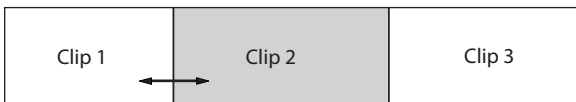

**13** If you drag to the left, the crossfade will be adjusted as in step 8, so drag to the right first.

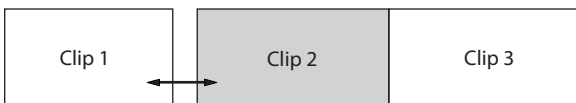

**14** Then, drag to the left to adjust the clip border.

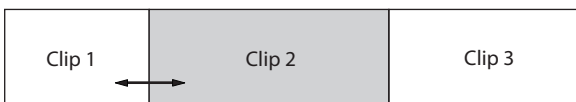

**15** To move the clip border set in step 11 to the right, place the double-headed arrow cursor little to the right of the border and click to make Clip 1 active.

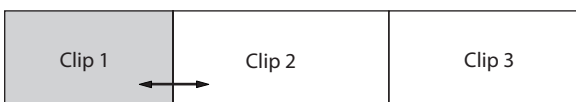

**16** If you drag to the right, the crossfade will be adjusted as in step 5, so drag to the left first.

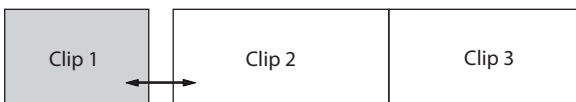

**17** Next, drag to the right to adjust the position of the clip border.

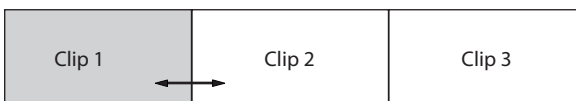

## Fade-in, fade-out and crossfade curves

Select the Object tool.

Double-click on a clip to open the *CLIP PROPERTIES* dialogue or double-click on a crossfade to open the *CROSSFADE PROPERTIES* dialogue. In each dialogue you can alter fade curves.

Please refer to “Clip properties” on page 35 of this manual for further information.

## Audio Processing

### Pitch/Time Stretch

Selecting this item from the *Process* menu opens the *Time Compression/Pitch Shift* window. There are two options in this window.

*Time Compression* allows the length of a clip to be changed without changing the pitch. Use a mouse and keyboard to set the length of a clip.

The start time for the clip remains the same while the end point changes to reflect the new length. The clip’s fade in or out remains non-destructive.

*Pitch Shift* allows the pitch of a clip to be changed without changing the length.

Click *OK* to process the clip.

### Consolidate

Selecting this item from the *Process* menu merges all selected clips or time into one audio file. Any crossfades or fade ins/outs that were added to the clip are also written to the new clip. This command may be used before exporting all of the edits on a track as one long Broadcast WAVE file.

Audio clips that are merged using the consolidate function must be given a new name. When you execute the *Consolidate* item from the *Process* menu a naming screen opens.

# 7 – Mixer

---

## Mixer Interface

---

### Mixer Introduction

The X-48MKII includes a software digital mixer/router with the following features:

- 48 playback channels, each with 4-band parametric EQ and compression
- Level, pan, solo and mute controls
- Input and output source selection per track/channel
- 6 aux sends, pre or post-fader
- 6 stereo aux returns
- 12 stereo subgroups
- Dynamic automation engine supporting mouse-drawn break-point style automation

---

### Mixer Bypass

When you first use the X-48MKII, the mixer section is disabled to improve input to output delay and CPU usage. Before using any of the mixer functions you need switch off Mixer Bypass.

To do this:

- 1 **Click the *Windows* menu and choose *Settings***
- 2 **Select the *System* tab. Uncheck the box labeled *Mixer Bypass*.**

---

### DSP View



Click the *DSP* button pictured above or press **F6** on the keyboard to open the DSP panel. When you open this window, you should see five panes (you may need to click the reveal triangle or scroll down):

#### Track

The Track section includes the fader, meter and pan controls. There's a record arming button, input monitor button, solo and mute buttons. The *Mix* button sends that track/channel to the Master output. You also get a field to name the track and another input and output menu for setting the source and destination for your track.

#### Aux Sends

Aux Sends shows the six aux sends and allows you to send the selected channel to them. The *Pre* button, when lit, makes these pre-fader sends. The *On* button turns the send on or off. The knob at the bottom shows the amount of that channel sent to the send.

#### Dynamics

Dynamics is a compressor for the selected track. Threshold changes the channel's compressor threshold and is displayed in dBfs. *Ratio* is the amount of gain reduction that occurs after the audio crosses the threshold. *Attack* and *Release* control the amount of time until gain reduction is fully-functional, and *Soft* applies a soft knee for extreme ratio settings. *On* turns the effect on and off and *Gain* is a post-compressor makeup stage.

#### Equalizer

The Equalizer section houses a four-band full parametric EQ section. The *On* button at the top-right corner of this panel switches the EQ on, and the *On* button above each band switches that band on. (Note that you need to press two *On* buttons to hear EQ, the master *ON* button and one band's *ON* button.) The *Type* pulldown menu gives you a choice of *Low Shelf*, *High Shelf*, *Peaking*, *Low Pass* and *High Pass* for each band. You can use the Gain, Frequency and Q knobs to change EQ, or grab the dots in the graphic display.

- You can double-click number boxes for faders and pan controls, as well as for *AUX SEND*, *DYNAMICS*, *EQUALIZER* and other items on the *DSP* screen and directly input numerical values.
- Hold the keyboard Control key while clicking on the pan control of a track to set the pan value to the center (C).
- Hold the keyboard Control key while clicking on the fader of a track to set the fader value to 0 dB.
- Hold the keyboard Shift key while clicking on the pan or fader of a track and then drag to copy that pan or fader value to other tracks.
- Hold the keyboard Alt key while clicking on a control or fader to make precise adjustments.

---

### Mixer Tabs

There are six tabs at the bottom of the VGA display: Click the tab or press the associated function key.

- |                   |  |
|-------------------|--|
| <b>Tracks</b>     | Track/waveform view ( <b>F1</b> )                            |
| <b>Ch. 1-24</b>   | First 24 channels of the mixer ( <b>F2</b> )                 |
| <b>Ch. 25-48</b>  | Second 24 channels of the mixer ( <b>F3</b> )                |
| <b>Groups</b>     | Subgroups and aux returns ( <b>F4</b> )                      |
| <b>Masters</b>    | Master output ( <b>F5</b> )                                  |
| <b>Big Meters</b> | Level meters for all 48 tracks are shown filling the screen. |

All of the mixer channels, groups and masters are located in one large window, so you can see channels 12-35 if necessary.

## Automation



To display automation, click the button pictured above or press **Alt-A**. You can automate the level of a track using this, and also play back automation from imported projects. The edit tools change in this mode:

- **Use the Cursor tool (click the “+” button or press F8) to write automation. Click and drag on a track to write new automation points. Automation can be enabled by track using WRITE switches.**
- **If you mouse over one of the automation points with the Cursor tool, your cursor turns into the Finger tool. Click and drag any automation point to change its level or time position. When writing automation data, the fader for each track is shown at the 0 dB line. The cursor position shows the fader volume.**
- **In automation mode, the Smart tool becomes an Eraser so that you can delete automation entries.**
- **Use the I-beam tool to select automation. You can cut, copy, paste or delete automation from the keyboard or *Edit* menu.**
- **Place a check next to *Playback Automation Bypass* under *Options* to disable automation during playback.**

## Third-Party Plug Ins

Support will not be provided to use VST plug-ins from Waves, Antares, or other companies. Installing them could cause problems.

### CAUTION

If problems should occur with the unit, reinstalling its software from the System Restore CD might be necessary.

## Routing

Each recorder track goes directly to the mixer channel that has the same number as the track. Mixer channels can be routed to various destinations, like physical outputs or Groups. Click the bottom-most text display on a mixer channel to reveal a menu of output routing choices, or open the DSP View to see the same menu along with other parameters of that mixer channel. You can change the output to a group or pair of outputs for submixing use, see the next section for examples.

## Mixer Applications

### Submixing

One of the typical uses for the subgroups is to combine tracks when you do not have enough mixer inputs for your session. For example, 17 tracks of percussion can be combined into a stereo group then sent through a pair of outputs to come up on a pair of faders on your console.

To use this feature:

- 1 **Make sure *Mixer Bypass* is disabled, see “Mixer Bypass” on page 46.**
- 2 **Click on the tab at the bottom of the screen where your tracks are, such as *Ch. 1-24*.**
- 3 **Find your track in the mixer view. You can change the level, pan it left or right, add EQ, etc.**
- 4 **Click the *Output field* at the bottom of the channel strip. This opens a menu of options. Mouse over the *Groups* submenu and choose a stereo group from 1 to 12.**
- 5 **Select the *Groups* tab at the bottom of the screen. Click on the output field at the bottom of the group channel. Select *Stereo Outs* and choose a pair of outputs for your Group.**

### Monitoring While Recording

Another useful feature of the mixing engine is to monitor tracks while recording. During a live event, the X-48MKII can serve as a 48-track recorder as well as your monitor mixer. Connect your mic preamps to the (optional) analog inputs and connect the S/PDIF output to a D/A converter or 2-track recorder, like the TASCAM DV-RA1000HD. You can then monitor through the D/A converter or recorder using headphones or monitors.

To set up the X-48MKII for record monitoring:

- 1 **Make sure *Mixer Bypass* is disabled. (See “Mixer Bypass” on page 46.)**
- 2 **Check your channel strips to make sure the *MIX* button is on/green so that tracks are being routed to the stereo mix out.**
- 3 **Click on the *Masters* tab at the bottom of the screen.**
- 4 **Click the *Output field* on the *Master* channel on the right side of this window. This opens a menu of options. Mouse over the *Stereo Outputs* submenu and choose *SPDIF*.**
- 5 **Connect the S/PDIF digital out to the S/PDIF digital in on your D/A converter or recorder. Change the on-screen mixer channels to mix. Since the mixer is after the recorder, any changes made to the monitor mix will not affect the recording.**

---

### Final Mix

It is possible to complete your project entirely inside the X-48MKII. You can add EQ and compression and automate channel levels during mixdown. You will still need a master recorder to monitor and capture the final mix, like the TASCAM DV-RA1000HD.

To mix on the X-48MKII:

- 1 Click the *Output* field on the *Master* channel on the right side of this window. This opens a menu of options. Mouse over the *Stereo Outputs* submenu and choose *SPDIF*.**
- 2 Make sure that the *Mix* button is on/green for any tracks/channels you want to go to the Master out.**
- 3 Connect the S/PDIF digital out to the S/PDIF digital in on your D/A converter or recorder. Change the on-screen mixer channels and DSP settings to mix your project.**



---

## Media and formats

---

### Recording media

Hard disk

### File system

NTFS

### File format

BWF (Broadcast Wave Format)

### Number of channels

48 channels (44.1/48/88.2/96 kHz)

### Quantization rate

16 bit, 24 bit, 32-bit floating point

### Sampling frequencies

42.336k (44.1k × 24/25), 44.056k (44.1k–), 44.1k, 44.144k (44.1k+), 45.938k (44.1k × 25/24), 46.080k (48k × 24/25), 47.952k (48k–), 48k, 48.048k (48k+), 50k (48k × 25/24), 84.672k (88.2k × 24/25), 88.112k (88.2k–), 88.2k, 88.288k (88.2k+), 91.875k (88.2k × 25/24), 92.160k (96k × 24/25), 95.904k (96k–), 96k, 96.096k (96k+), 100k (96k × 25/24) Hz

Note: + is 0.1% pull up, – is 0.1% pull down

### Clock references

Internal, Word in, Digital slot 1/2, SPDIF IN, TDIF Port 1

### Timecode frame

23.976NDF, 24NDF, 24.975NDF, 25NDF, 29.97DF, 29.97NDF, 30DF, 30NDF

---

## Digital audio input/output

---

### TDIF connector (x6)

Connector: DB25 (Female) connector (mm screws)

Format: Conforms to TDIF-1 standards

Word length: 24 bit

### S/PDIF IN/OUT connector

Connector: RCA connector

Format: IEC 60958-3 (S/PDIF)

---

## Control input/output

---

### WORD SYNC IN connector

Connector: BNC (Unbalance), TTL level, 75Ω termination (auto on/off selection)

### WORD SYNC TRU, WORD SYNC OUT connector

Connector: BNC (Unbalance), TTL level, 75Ω

### MIDI IN, MIDI OUT connector

Connector: DIN 5 pin

Format: Standard MIDI format

### TIME CODE IN, TIME CODE OUT connector

Connector: 6.3 mm (1/4") TRS standard jack (Tip: HOT, Ring: COLD, Sleeve: GND)

Format: Conforms to SMPTE standards

### FOOT SW connector

Connector: 6.3 mm (1/4") TS standard jack (Tip: HOT, Sleeve: GND)

### REMOTE connector

Connector: DE9 (Female, mm screws), Conforms to RS-422, Sony 9-pin serial protocol (P2)

### USB port (x4)

Connector: A type, 4 pin

Protocol: Conforms to USB 2.0 High speed (480 Mbps)

### 100/1000 connector

Connector: RJ45 LAN connector

100BASE-TX/1000BASE-TX Ethernet

### VGA connector

Connector: DE15 (Female) VGA connector (inch screws)

### MOUSE connector

Connector: Mini DIN connector (PS/2)

### Keyboard connector

Connector: Mini DIN connector (PS/2)

### eSATA connector

Connector: eSATA (External Serial ATA) 7 pin (Female)

Specifications: SATA2, 3 Gb/s

---

## General

---

### Power

AC 100-240 V, 50-60 Hz

### Power consumption

49 W

### Dimensions (W x H x D)

483 x 184 x 439 mm/19.02 x 7.24 x 17.28 in.

### Weight

13.7 kg/30.2 lb

### Operating temperature

5 - 35°C/41 - 95°F

# 8 – Specifications

## Options

### IF-AN24X

24-channel analog input and output card with 96 kHz-compatible connectors (D-sub 25-pin, inch screws)

### IF-AE24X

24-channel AES/EBU input and output card with 96 kHz-compatible connectors (D-sub 25-pin, inch screws)

### IF-AD24

24-channel ADAT input and output card

## Dimensional drawings

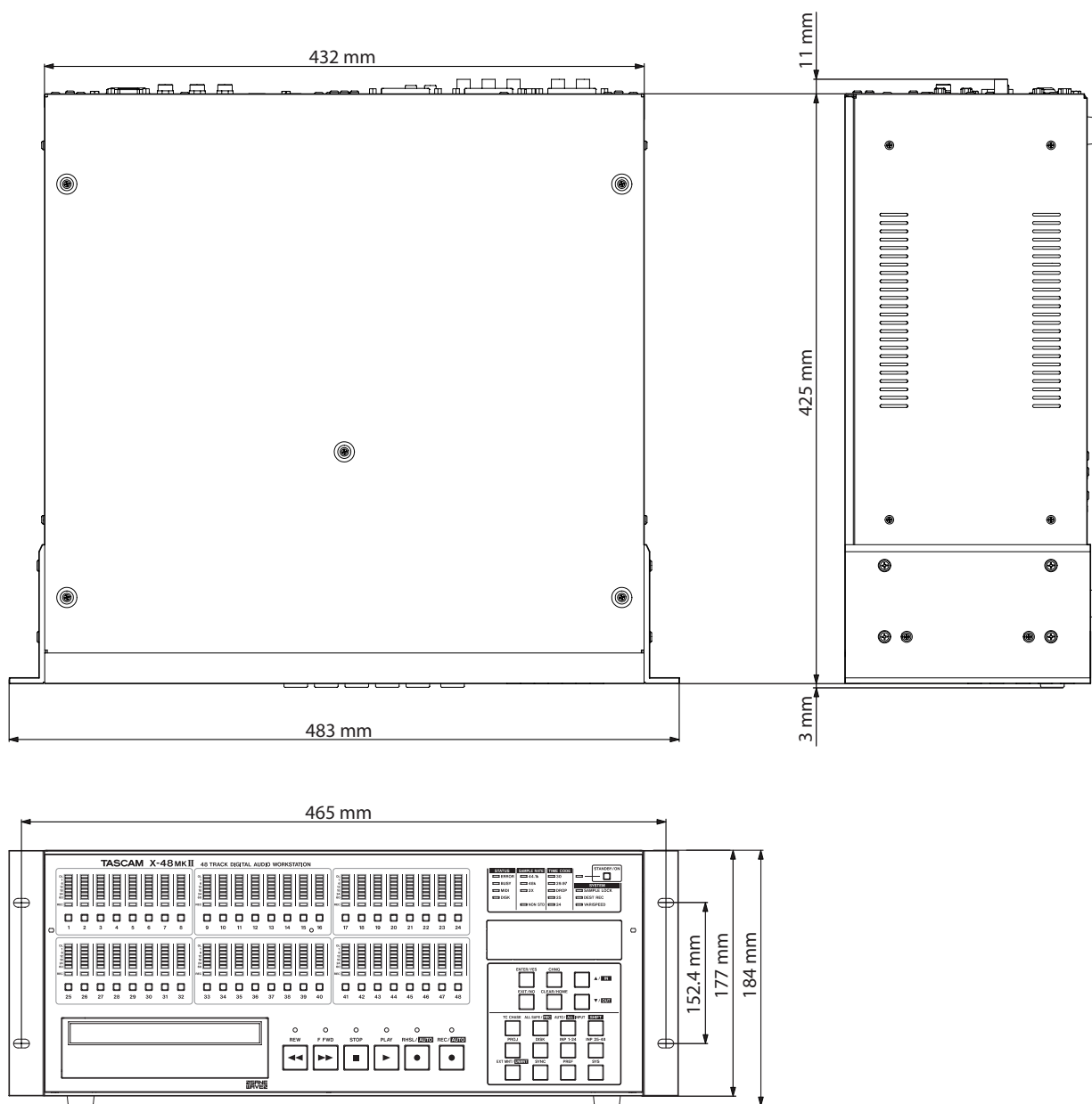

- Illustrations in this manual might differ from the actual product.
- In order to improve the product, specifications and appearance could be changed without prior notice.

## Functions controlled using a mouse and display

| Function list  | Operation/Confirmation                |   |                    |
|--|---------------------------------------|---|--------------------|
|  | VGA display, MENU                     | Front panel operation (press these buttons to open the menu item) | Keyboard shortcut  |
| Create new project   | File → New Project...                 | PROJ → ▲/▼ → (New) → CHNG   | Ctrl + N           |
| Open existing project  | File → Open Project...                | PROJ → ▲/▼ → (Open) → CHNG  | Ctrl + O           |
| Save current project   | File → Save Project                   | PROJ → ▲/▼ → (Save) → CHNG  | Ctrl + S           |
| Save current project with a different name   | File → Save Project As...             | PROJ → ▲/▼ → (Save As...) → CHNG                                  | Ctrl + Shift + S   |
| Convert project to non-destructive mode  | File → Convert To Non-Destructive     | —   | —                  |
| Import OpenTL project  | File → Import Project...              | —   | Ctrl + Shift + I   |
| Export project as OpenTL or AAF  | File → Export Project...              | —   | Ctrl + Shift + E   |
| Import audio file  | File → Import Audio File...           | PROJ → ▲/▼ → (Open) → CHNG  | Shift + Alt + I    |
| Open file manager screen   | File → File Manager...                | —   | Ctrl + F           |
| Open disk management screen  | File → Disk Management...             | —   | —                  |
| Open benchmark screen for hard disk being used   | File → Drive Benchmarking...          | —   | —                  |
| Launch shared drive mode when connected to a network   | File → Drive Sharing...               | —   | —                  |
| Set the built-in clock   | File → Set Date and Time              | —   | —                  |
| Set the name of the X-48MKII   | File → Set X48 name...                | —   | —                  |
| Open the Launch External Application screen  | File → Launch External Application... | —   | —                  |
| Launch MX View for MX-2424 units   | File → Launch MX View...              | —   | —                  |
| Launch TASCAM mixer companion  | File → Launch Mixer Companion...      | —   | —                  |
| Shutdown the unit  | File → Shutdown...                    | STANDBY/ON →  | —                  |
| Undo editing or recording, etc.  | Edit → Undo                           | —   | Ctrl + Z           |
| Redo the last undone operation   | Edit → Redo                           | —   | Ctrl + Y           |
| Copy the audio clip or selection   | Edit → Copy                           | —   | Ctrl + C           |
| Cut the designated audio clip range (and keep it in the copy buffer)                               | Edit → Cut                            | —   | Ctrl + X           |
| Delete that audio clip or designated range   | Edit → Delete                         | —   | Delete (Backspace) |
| Paste the data in the copy buffer  | Edit → Paste                          | —   | Ctrl + V           |
| Paste multiple times (number can be set)   | Edit → Repeat Paste                   | —   | Ctrl + Alt + V     |
| Trim around a designated range in an audio clip and discard the rest                               | Edit → Crop                           | —   | Ctrl + U           |
| Divide an audio clip   | Edit → Split                          | —   | Ctrl + E           |
| Insert a period of silence at the selected interval, shifting the existing audio data to after it. | Edit → Insert Time                    | —   | Ctrl + T           |
| Delete the selected interval, shifting the audio after it forward                                  | Edit → Delete Time                    | —   | —                  |
| Add a marker   | Edit → New Marker                     | —   | Num + Return       |
| Playback the designated range from its starting point  | Edit → Play From Selection            | —   | P                  |
| Open the History List screen   | Edit → History List                   | —   | Ctrl + H           |
| Activate the I-Beam Tool for editing   | Edit → I-Beam and VGA icon            | —   | F9                 |

## 9 – Appendix

| Function list                                  | Operation/Confirmation                               |   |                                     |
|--|--|---|-------------------------------------|
|  | VGA display, MENU                                    | Front panel operation (press these buttons to open the menu item) | Keyboard shortcut                   |
| Activate the Object Tool for editing           | Edit → Object and VGA icon                           | —   | F8                                  |
| Activate the Smart Tool for editing            | Edit → Smart and VGA icon                            | —   | F11                                 |
| Activate the Magnify Tool for editing          | Edit → Magnify and VGA icon                          | —   | F12                                 |
| Select all audio clips on a track              | Edit → Select All On Track                           | —   | Ctrl + A<br>(on the selected track) |
| Select all audio clips                         | Edit → Select All                                    | —   | —                                   |
| Open the Pitch/Time Stretch screen             | Process → Pitch/Time Stretch                         | —   | —                                   |
| Open the Consolidate (for audio clips) screen  | Process → Consolidate                                | —   | —                                   |
| Set mixer meter display to pre-fader           | Options → Meters → Mode → Pre-Fader                  | —   | —                                   |
| Set mixer meter display to post-fader          | Options → Meters → Mode → Post-Fader                 | —   | —                                   |
| Turn peak hold ON/OFF                          | Options → Meters → Peak Hold                         | —   | —                                   |
| Change track meter display to GROUPS and AUXES | Options → Meters → View Masters                      | —   | —                                   |
| Clear overloads                                | Options → Meters → Clear Overloads                   | —   | —                                   |
| Select Solo Mix                                | Options → Solo → Solo Mix                            | —   | —                                   |
| Select Solo Exclusive                          | Options → Solo → Solo Exclusive                      | —   | —                                   |
| Unsolo the selected track                      | Options → Solo → Clear Solos                         | —   | —                                   |
| Select disk usage display                      | Options → Disk Usage Display → Disk Usage            | —   | —                                   |
| Select remaining recording time display        | Options → Disk Usage Display → Record Time Remaining | —   | —                                   |
| Enable snapping                                | Options → Snapping → Enable Snapping                 | —   | —                                   |
| Show the snap grid                             | Options → Snapping → Draw Snap Grid                  | —   | —                                   |
| Set the snapping unit to hours                 | Options → Snapping → Snap To → Hours                 | —   | —                                   |
| Set the snapping unit to minutes               | Options → Snapping → Snap To → Minutes               | —   | —                                   |
| Set the snapping unit to seconds               | Options → Snapping → Snap To → Seconds               | —   | —                                   |
| Set the snapping unit to frames                | Options → Snapping → Snap To → Frames                | —   | —                                   |
| Set the snapping unit to subframes             | Options → Snapping → Snap To → Subframes             | —   | —                                   |
| Disable scrolling                              | Options → Scrolling → None                           | —   | —                                   |
| Enable automatic scrolling                     | Options → Scrolling → Auto-Scroll                    | —   | —                                   |
| Set to scroll by page                          | Options → Scrolling → Page-Flip                      | —   | —                                   |
| Set the timebar unit to SMPTE                  | Options → Timebar Format → SMPTE                     | —   | —                                   |
| Set the timebar unit to samples                | Options → Timebar Format → Samples                   | —   | —                                   |
| Open the Color Setup screen                    | Options → Color Setup                                | —   | Ctrl + 6                            |
| Enable looping                                 | Options → Transport → Enable Looping                 | —   | —                                   |
| Enable one button recording                    | Options → Transport → One Button Record              | —   | Alt + F12                           |

| Function list                                     | Operation/Confirmation  |   |                   |
|---|---|---|-------------------|
|   | VGA display, MENU   | Front panel operation (press these buttons to open the menu item) | Keyboard shortcut |
| Disable Auto Input                                | Options → Auto Input → Off  | AUTO/ALL INPUT  | Alt + F9          |
| Enable Auto Input                                 | Options → Auto Input → On   | SHIFT + AUTO/ALL INPUT  | Alt + F9          |
| Enable Auto Input ADR Monitoring Mode             | Options → Auto Input → ADR  | —   | —                 |
| Enable All Input                                  | Options → All Input   | AUTO/ALL INPUT  | Alt + F10         |
| Enable All Safe                                   | Options → All Safe  | ALL SAFE/REC  | Alt + F11         |
| Enable automation writing                         | Options → Automation Write  | —   | —                 |
| Set to ignore automation data during playback     | Options → Automation Bypass                                       | —   | —                 |
| Check the X-48MKII software version               | Windows → About   | —   | —                 |
| Open settings screen                              | Windows → Settings  | —   | Alt + F8          |
| Open Display Settings screen                      | Windows → Display Settings...                                     | —   | —                 |
| Display information about the selected audio clip | Windows → Clip Properties...                                      | —   | Ctrl + 2          |
| Open Audio Pool screen                            | Windows → Audio Pool...   | —   | Ctrl + P          |
| Open Markers screen                               | Windows → Markers   | —   | Ctrl + 3          |
| Open I/O Marker Properties screen                 | Windows → I/O Marker Properties                                   | —   | Ctrl + 4          |
| Open Time Display screen                          | Windows → Time Display  | —   | Ctrl + 5          |
| Open theatre playlist screen                      | Windows → Theatre Playlist  | —   | —                 |
| Enable/disable Meter bridge display               | Windows → Panels → Meterbridge                                    | —   | —                 |
| Enable/disable Track Overview display             | Windows → Panels → Track Overview                                 | —   | —                 |
| Enable/disable clip property display              | Windows → Panels → Information                                    | —   | —                 |
| Enable/disable DSP screen display                 | Windows → Panels → Channel DSP View                               | —   | F6                |
| Show Tracks screen                                | Windows → Tracks or Tracks tab                                    | —   | F1                |
| Show track 1-24 mixer screen                      | Windows → Ch.1-24 or Ch.1-24 tab                                  | —   | F2                |
| Show track 25-48 mixer screen                     | Windows → Ch.25-48 or Ch.25-48 tab                                | —   | F3                |
| Show Groups mixer screen                          | Windows → Groups or Groups tab                                    | —   | F4                |
| Show stereo and AUX channel mixer screen          | Windows → Masters or Masters tab                                  | —   | F5                |
| Show large 48-track meter screen                  | Windows → Big Meters (or the screen tab on the connected display) | —   | F7                |
| Close all windows                                 | Windows → Clear All Windows                                       | —   | Ctrl + W          |

## 9 – Appendix

### Front panel function list

| Front panel           | Description  |   |
|-----------------------|--|---|
| Track meter 1-48      | Show each track's signal level (–60 dBFS - 1 dBFS) and overload status   |   |
| REC LED 1-48          | Show each track's record arming status   |   |
| REC key 1-48          | Use to arm each track for recording.   |   |
| STATUS indicator      | ERROR indicator  | Blinks when a system error occurs   |
|                       | BUSY indicator   | Blinks when the system is busy  |
|                       | MIDI indicator   | Lights when a MIDI command is input   |
|                       | DISK indicator   | Lights when the built-in hard disk is being accessed  |
| SAMPLE RATE indicator | Shows the currently selected sampling frequency  |   |
| TIME CODE indicator   | Shows the currently selected frame rate  |   |
| SYSTEM indicator      | SAMPLE LOCK indicator  | When syncing to an external clock source, lights when the unit is locked and blinks when not locked |
|                       | DEST REC indicator   | Lights when in destructive ("tape") mode  |
|                       | VARISPEED indicator  | Lights when varispeed is enabled  |
| STANDBY/ON switch     | Turn unit (power) on and puts it into standby; press and hold for several seconds to force the unit into standby   |   |
| Built-in DVD drive    | Use DVD discs to backup and restore projects and import and export files   |   |
| Transport button      | Operate the recorder transport   |   |
| Display               | Use to view information and settings   |   |
| ENTER/YES button      | Use to confirm and execute items and move down levels in the settings menu   |   |
| EXIT/NO button        | Use to cancel operations and settings and move up levels in the settings menu  |   |
| CHNG button           | Change setting items   |   |
| CLEAR/HOME button     | Use to clear a setting or return to the LCD home position  |   |
| ▲/▼ button            | Moves the cursor. When SHIFT is active, sets punch-in and punch-out points   |   |
| TC CHASE button       | Turn the timecode synchronization function ON/OFF  |   |
| ALL SAFE/REC button   | When SHIFT is not active, use to prevent/allow recording on all tracks. When SHIFT is active, use to put all tracks into recording standby or take them out of standby.  |   |
| AUTO/ALL INPUT button | When SHIFT is not active, use to turn Auto Input mode ON/OFF. When SHIFT is active, use to set input monitoring of all tracks.   |   |
| SHIFT button          | Turn SHIFT ON/OFF. To use the shift function of buttons that have one, <ul style="list-style-type: none"> <li>• When the SHIFT button is lit, press the button with the shift function</li> <li>• While pressing and holding the SHIFT button, press the button with the shift function</li> </ul> |   |
| PROJ button           | Open the PROJ menu where you can create, open, save, erase and copy projects   |   |
| DISK button           | Open the DISK menu where you can check the open space on the built-in hard disk and format it  |   |
| INP 1-24 button       | Open the input settings menu for tracks 1-24   |   |
| INP 25-48 button      | Open the input settings menu for tracks 25-48  |   |
| EXT MNT/UNMNT button  | Mount and unmount USB external storage devices   |   |
| SYNC button           | Open the synchronization settings menu where you can set sampling frequency, clock source and other audio synchronization and timecode synchronization settings  |   |
| PREF button           | Open a menu where you can set various preferences  |   |
| SYS button            | Open the system settings screen where you can save and recall system settings, as well as make MIDI and network settings   |   |

|           | Main unit settings menu | Description  |
|-----------|-------------------------|--|
| DISK      | Free Space              | View open space on each hard disk                                    |
|           | Quick Format            | Format external hard disks   |
| INP 1-24  | IO Card Select 1-8      | Select track 1-8 inputs  |
|           | Input Routing 1-8       | Set track 1-8 input routings   |
|           | IO Card Select 9-16     | Select track 9-16 inputs   |
|           | Input Routing 9-16      | Set track 9-16 input routings  |
|           | IO Card Select 17-24    | Select track 17-24 inputs  |
|           | Input Routing 17-24     | Set track 17-24 input routings                                       |
| INP 25-48 | IO Card Select 25-32    | Select track 25-32 inputs  |
|           | Input Routing 25-32     | Set track 25-32 input routings                                       |
|           | IO Card Select 33-40    | Select track 33-40 inputs  |
|           | Input Routing 33-40     | Set track 33-40 input routings                                       |
|           | IO Card Select 41-48    | Select track 41-48 inputs  |
|           | Input Routing 41-48     | Set track 41-48 input routings                                       |
| SYNC      | Sample Rate             | Set the sampling frequency   |
|           | Sample Clock Source     | Set the audio clock source   |
|           | BNC Clock In            | Set the word clock input frequency                                   |
|           | BNC Clock Out           | Set the word clock output frequency                                  |
|           | Word Out Polarity       | Set the word clock output polarity                                   |
|           | Frame Rate              | Set the timecode frame type  |
|           | Control Mode            | Set the timecode synchronization mode                                |
|           | Output Muting           | Set the timecode output muting method                                |
|           | Chase Freewheel         | Set the freewheel time when functioning as a timecode slave          |
|           | Chase Relock            | Set the relock when functioning as a timecode slave                  |
|           | Chase Relock Thresh     | Set the relock threshold value when functioning as a timecode slave  |
|           | Chase Offset            | Set the time code offset when functioning as a timecode slave        |
|           | Resolve to Video In     | Set to synchronize timecode output with VIDEO IN signal frame-edges  |
|           | Chase Lock Deviation    | Display time difference between timecode input and internal timecode |

## 9 – Appendix

|      | Main unit settings menu | Description   |
|------|-------------------------|---|
|      | Auto Chase              | Turn Auto Chase mode ON/OFF   |
|      | One Button Record       | Enable recording with just the record button  |
|      | One Button Rehearse     | Enable activating rehearsal mode with just the rehearsal button   |
|      | Update Punch Points     | Set whether or not punch-in and punch-out point settings are automatically updated when starting and stopping recording |
|      | Track Key Punch         | Set whether REC keys 1-48 can be used to punch-in and punch-out   |
|      | Use Pre/Post-Roll       | Turn pre-roll and post-roll ON/OFF  |
|      | Pre-Roll                | Set the pre-roll time   |
|      | Post-Roll               | Set the post-roll time  |
|      | TimeCode Display        | Set the time axis display unit  |
|      | Mixer Bypass            | Turn mixer bypass mode ON/OFF   |
|      | Loop Mode               | Select the loop playback method   |
|      | AES 2X Mode             | Set the AES/EBU card transmission mode when using 2x sampling frequencies.  |
|      | S/PDIF Input SRC        | Turn the S/PDIF input sampling rate converter ON/OFF  |
|      | S/PDIF Pro Mode         | Set the S/PDIF input professional mode  |
| PREF | Auto Input              | Select the auto input mode  |
|      | Punch Crossfade         | Set the crossfade time when punch recording   |
|      | EDL Crossfade Shape     | Set the EDL crossfade shape type  |
|      | Overload LED Time       | Set how long the (overload) indicator lights  |
|      | Audio File Naming       | Set how names are given automatically to audio clips  |
|      | Auto Save               | Turn the EDL automatic saving function ON/OFF   |
|      | Auto Save Time          | Set the time interval between when saving when using EDL automatic saving   |
|      | P2 Track Arm            | Set whether or not tracks can be armed over the Sony 9-pin connection   |
|      | P2 Punch Delay          | Set the amount of delay until execution after receiving a punch-in command over the Sony 9-pin connection               |
|      | P2 Chase Control        | Set the target chase source (LTC or MMC) when commanded to chase from the Sony 9-pin port.                              |
|      | Meters                  | Make various meter display settings   |
|      | Looping                 | Turn loop playback ON/OFF   |
|      | Scrolling               | Set track screen scrolling  |
|      | Load Last Project       | Set whether or not to load the project that was in use the last time the unit was shut down                             |
| SYS  | Settings                | View and save system settings   |
|      | Midi Device ID          | Set the MIDI device ID  |
|      | Network                 | Make various address settings for the LAN network   |
|      | About                   | Show the software version   |



## Shortcuts

| Category        | Function  | Keyboard shortcut                           |
|-----------------|---|---|
| Naming Channels | Move to beginning/end of edit contents              | Home / End                                  |
|                 | Move single letters at a time                       | Left/Right Arrow keys                       |
|                 | Select entire word                                  | Double-click on word                        |
|                 | Move down/up rows                                   | Tab/Shift + Tab                             |
| Dialog Boxes    | New Project   | Ctrl + N                                    |
|                 | Open Project  | Ctrl + O                                    |
|                 | Save Project  | Ctrl + S                                    |
|                 | Open Settings Window                                | Alt + F8                                    |
|                 | Save As...  | Ctrl + Shift + S                            |
|                 | File Manager  | Ctrl + F                                    |
|                 | Export Project                                      | Ctrl + Shift + E                            |
|                 | Import Project                                      | Ctrl + Shift + I                            |
|                 | Open Import Audio window                            | Alt + Shift + I                             |
|                 | Open Audio Pool                                     | Ctrl + P                                    |
| Editing         | Nudge selection or region right/left by Nudge value | +/- on numeric keypad only                  |
|                 | Select entire track in Edit window                  | Ctrl + A                                    |
|                 | Repeat Paste  | Ctrl + Alt + V                              |
|                 | Redo  | Ctrl + Y                                    |
|                 | Crop  | Ctrl + U                                    |
|                 | Insert Time   | Ctrl + T                                    |
|                 | Split   | Ctrl + E                                    |
|                 | Cycle through Edit Tools                            | ESC or simultaneously press both mouse keys |
|                 | Select entire region in Edit window                 | Double-click with I-Beam                    |
|                 | Cut   | Ctrl + X                                    |
|                 | Copy  | Ctrl + C                                    |
|                 | Paste   | Ctrl + V                                    |
|                 | Undo  | Ctrl + Z                                    |
|                 | Display History List                                | Ctrl + H                                    |
|                 | Delete (do not place in clipboard)                  | Delete (Backspace)                          |
|                 | Go to Song Start                                    | Home  |
|                 | Extend selection to Song Start                      | Shift + Home                                |
|                 | Go to end of session                                | End   |
|                 | Extend selection to end of session                  | Shift + End                                 |
|                 | Toggle Automation view                              | Alt + A                                     |
|                 | New Marker  | Enter on numeric keypad                     |
|                 | Play From Beginning of Selection                    | P   |
| F-Keys          | Select I-Beam Tool                                  | F9  |
|                 | Select Object Tool                                  | F8  |
|                 | Select Smart Tool                                   | F11   |
|                 | Select Magnify Tool                                 | F12   |
|                 | Show Track Screen                                   | F1  |
|                 | Show Mixer CH 1-24                                  | F2  |
|                 | Show Mixer CH 25-48                                 | F3  |
|                 | Show Groups Mixer                                   | F4  |
|                 | Show Master Mixer                                   | F5  |

## 9 – Appendix

| Category  | Function                                      | Keyboard shortcut                           |
|---|---|---|
| F-Keys  | Show Big Meter                                | F7  |
|   | Toggle DSP CH display                         | F6  |
|   | Toggle Auto Input (On/Off)                    | Alt + F9                                    |
|   | Toggle All Input                              | Alt + F10                                   |
|   | Toggle All Safe                               | Alt + F11                                   |
|   | Toggle One Button Record                      | Alt + F12                                   |
| Global  | Fine adjust mode                              | Ctrl + click on control                     |
|   | Increase or decrease track height             | Start + Up Arrow key/Start + Down Arrow key |
|   | Color Setup                                   | Ctrl + 6                                    |
|   | Audio Pool...                                 | Ctrl + P                                    |
|   | Markers                                       | Ctrl + 3                                    |
|   | I/O Marker Properties                         | Ctrl + 4                                    |
|   | Time Display                                  | Ctrl + 5                                    |
|   | Theatre Playlist                              | Ctrl + 7                                    |
| Clear All Windows   | Ctrl + W                                      |   |
| Recording and Playback  | Play/Stop                                     | 0 on numeric keypad                         |
|   | Rewind  | 1 on numeric keypad                         |
|   | F Fwd   | 2 on numeric keypad                         |
|   | Record  | 3 on numeric keypad                         |
|   | Stop recording                                | spacebar                                    |
|   | Start/stop playback                           | spacebar                                    |
|   | Solo-safe track                               | Ctrl + click on track solo enable button    |
|   | Punch In/Out of Record                        | Ctrl + spacebar or F12                      |
|   | Stop recording & do undo                      | Ctrl + . (period on a QWERTY keyboard)      |
|   | Toggle TC Chase (Online)                      | Ctrl + J or Alt + spacebar                  |
|   | Loop toggle                                   | Alt + L                                     |
|   | Toggle Pre/Post Roll                          | Ctrl + K                                    |
| Create a marker   | Enter on the numeric keypad                   |   |
| Timecode Data Entry   | Move sub-unit selection to the right          | . (period on a QWERTY keyboard)             |
|   | Move sub-unit selection to the left/right     | Left/Right Arrow keys                       |
|   | Increment/decrement the current sub-unit      | Up/Down Arrow keys                          |
| Clear entered numeric value and stay in time entry<br>Clear entered numeric value & exit time entry | Apply entered numeric value                   | Enter                                       |
|   | Clear entered numeric value & exit time entry | ESC   |
| Zoom  | Horizontal zoom in/out                        | Ctrl + @ / [                                |
|   | Vertical zoom in/out                          | Ctrl + Alt + @ / [                          |

## MIDI machine control (MMC) protocol

### List of supported MMC commands

STOP

PLAY

DEFERRED PLAY

FAST FORWARD

REWIND

RECORD STROBE

RECORD EXIT

CHASE

MMC RESET

WRITE

MASKED WRITE

READ

UPDATE

LOCATE

SEARCH

SHUTTLE

STEP

\* List of information fields that respond to WRITE, MASKED WRITE, READ and UPDATE commands

SELECTED TIME CODE

SIGNATURE

UPDATE RATE

MOTION CONTROL TALLY

VELOCITY TALLY

RECORD MODE

RECORD STATUS

TRACK RECORD STATUS

TRACK RECORD READY

GLOBAL MONITOR

RECORD MONITOR

### NOTE

See the MIDI Machine Control 1.0 specifications for details about how to use these commands.

## SONY P2 protocol

stop

play

sync, play

record

fast forward

rewind

cue, data

jog, forward

jog, reverse

shuttle, forward

shuttle, reverse

varispeed, forward

varispeed, reverse

select, ee, on

full, ee, on

full, ee, off

edit, on

edit, off

edit, preset

edit, field, select

current, time, sense

timer, mode, sense

# TASCAM

# X-48MKII

**TEAC CORPORATION**

Phone: +81-42-356-9143  
1-47 Ochiai, Tama-shi, Tokyo 206-8530, Japan

<http://tascam.jp/>

**TEAC AMERICA, INC.**

Phone: +1-323-726-0303  
7733 Telegraph Road, Montebello, California 90640 USA

<http://tascam.com/>

**TEAC CANADA LTD.**

Phone: +1905-890-8008 Facsimile: +1905-890-9888  
5939 Wallace Street, Mississauga, Ontario L4Z 1Z8, Canada

<http://tascam.com/>

**TEAC MEXICO, S.A. de C.V.**

Phone: +52-55-5010-6000  
Río Churubusco 364, Colonia Del Carmen, Delegación Coyoacán, CP 04100, México DF, México

<http://www.teacmexico.net/>

**TEAC UK LIMITED**

Phone: +44-8451-302511  
Suites 19 & 20, Building 6, Croxley Green Business Park, Hatters Lane, Watford, Hertfordshire, WD18 8TE, UK

<http://www.tascam.co.uk/>

**TEAC EUROPE GmbH**

Phone: +49-611-71580  
Bahnstrasse 12, 65205 Wiesbaden-Erbenheim, Germany

<http://tascam.de/>